

# Portfolio

*Nathan Garion*  
*2025 - 2026 / 4th Year*

*Interior Architecture*  
*& Product Design*

## Summary

Frisbee42 - 2026	• 4
Paley - 2025	• 8
Le Lab - 2024	• 12
Calcestruzzo - 2023	• 16
Cinta - 2025	• 18
Ionox - 2023	• 20
Split - 2025	• 22
IceBerg - 2022	• 24
Exo - 2024	• 26
Elastic - 2025	• 28
ThermoMug - 2023	• 30

# Frisbee42 - 2026

## Micro-architecture - Tensile structure

Frisbee42 is an installation that adapts to the uneven terrain of the Fort des Saumonards within the École 42 on the Île d'Oléron. Its shape represents movement and speed, reflecting its purpose, as it serves as the base, the Clubhouse, for a Disc Golf course inside the Fort. Designed for students seeking a challenge and wishing to explore the surroundings of the Fort, the course is made up of several sculptural targets; the goal being to use a flying disc, or frisbee, to reach each target from a set distance.

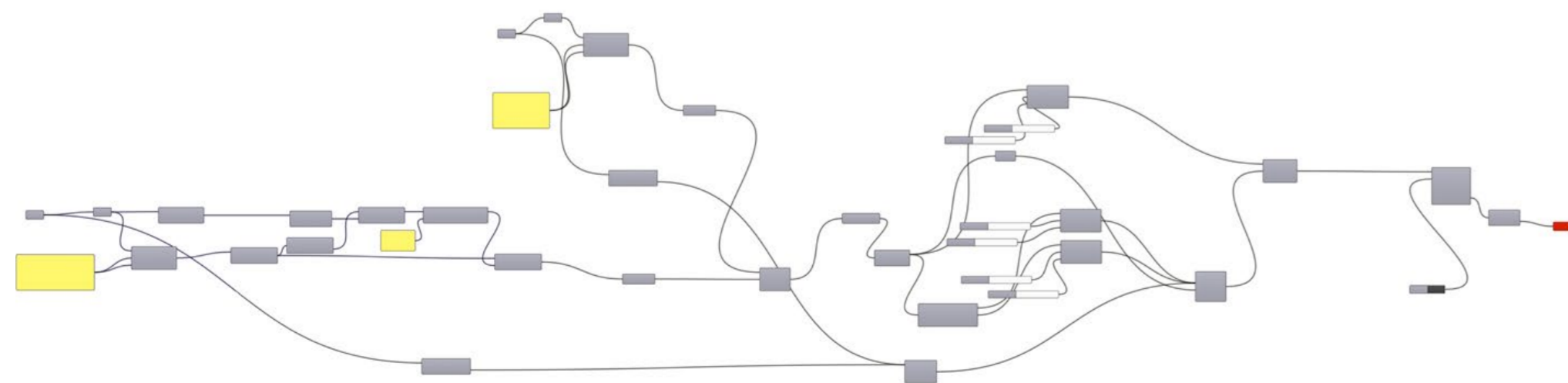
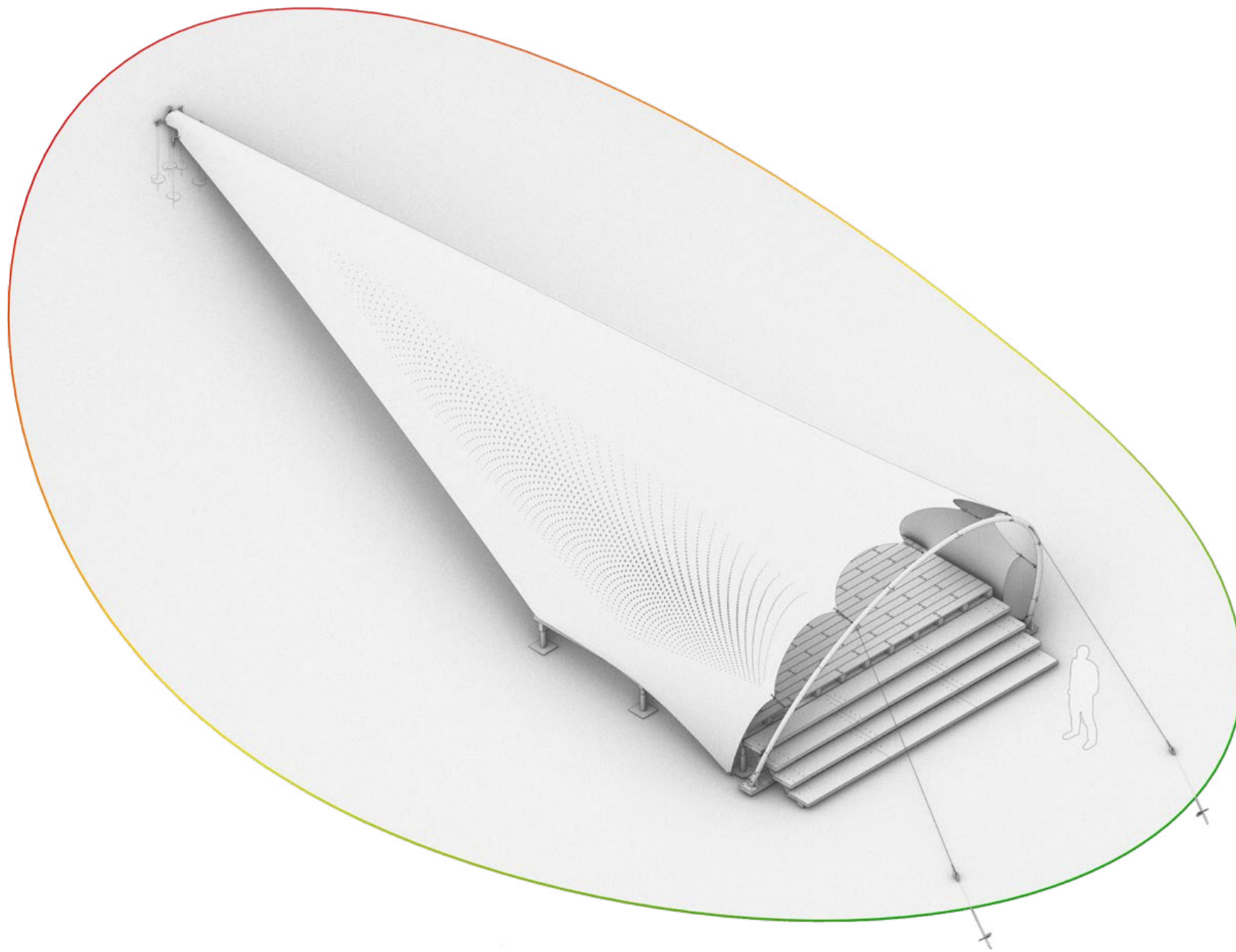

Grasshopper + Kangaroo script for the tensile structure

## Exploded isometrics & standard parts

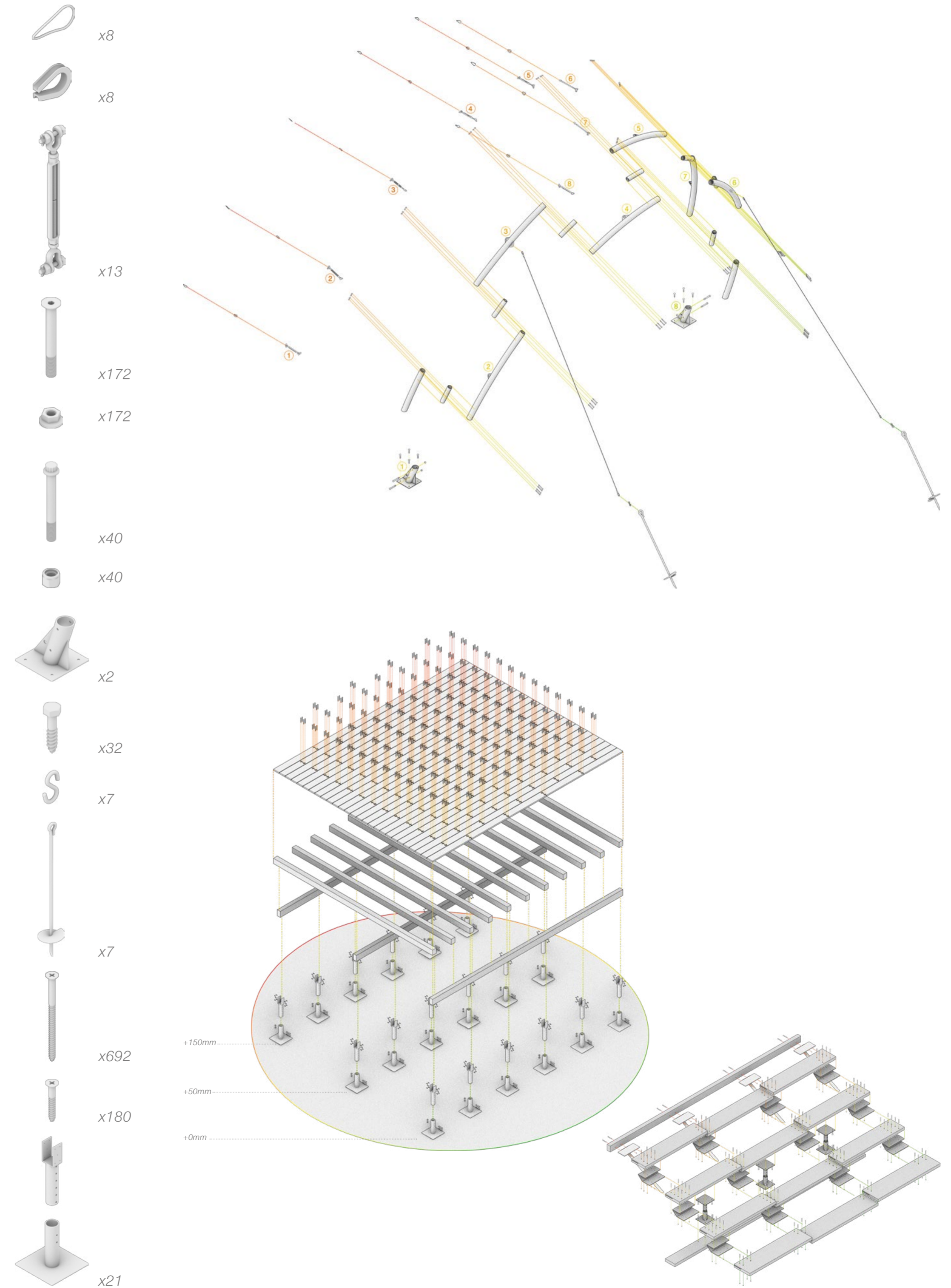

Concept

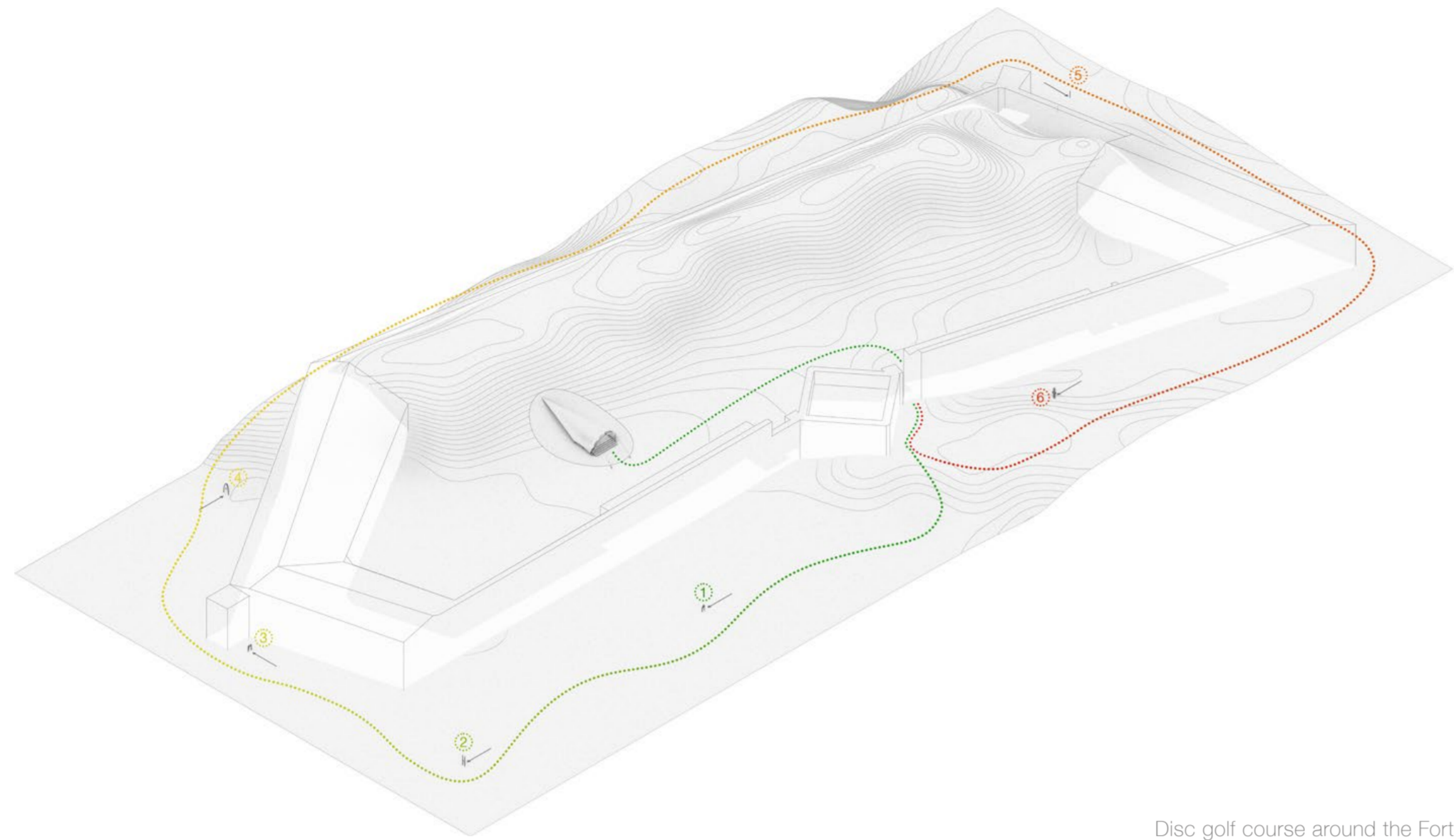

Disc golf course around the Fort

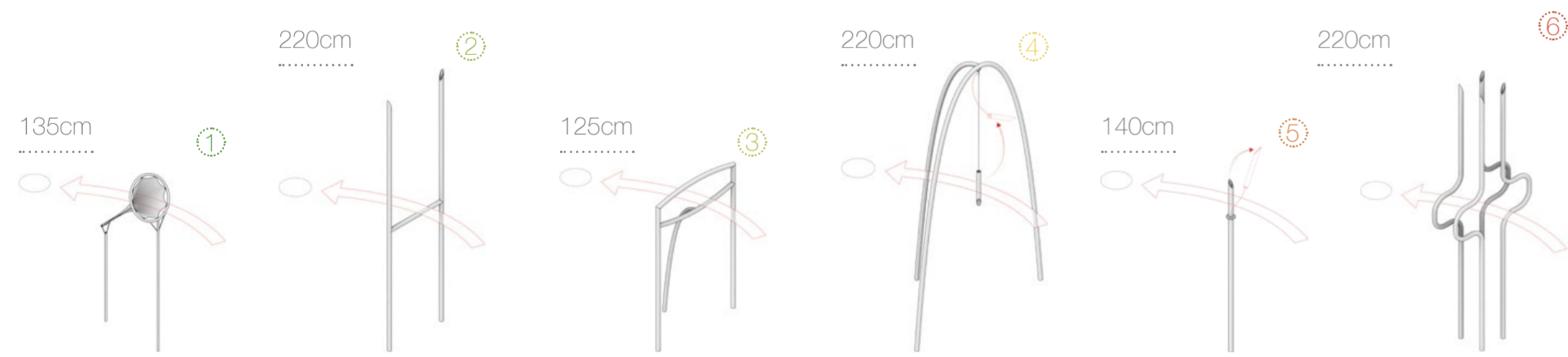

Sculptural targets

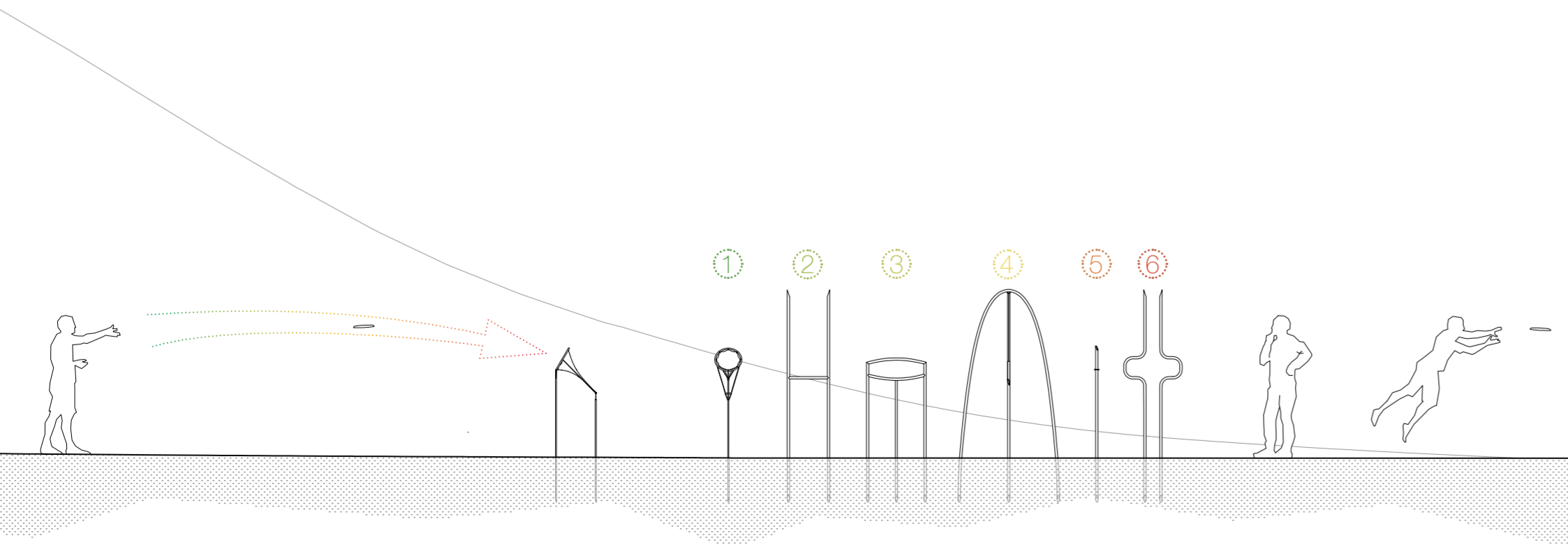

Renders



# Paley's castle - 2025

## Interior Architecture - Video game artist's residence

Long before Paley's castle was built, humans already inhabited the region: prehistoric tools remnants of a Gallo-roman temple and a Merovingian necropolis are all proofs of this vibrant human activity. In it's new era Paley is now a digital artist's residence, the residents are free to roam the site's 3 buildings to discover the region's rich history by finding 8 hidden symbols each related to a specific era.

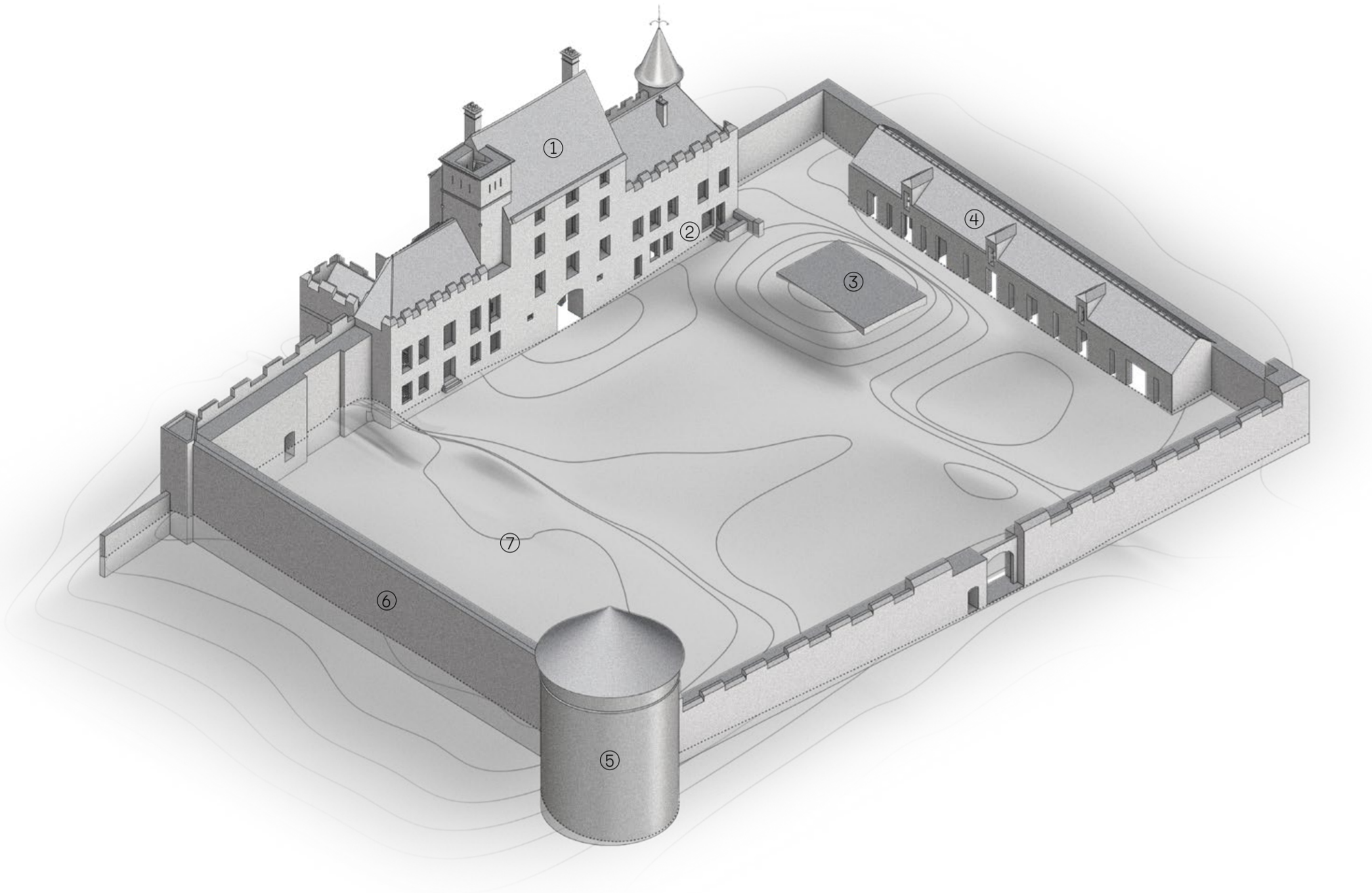

- ① Main house (bedrooms and commons)
- ② Owner's wing (GF & FF)
- ③ Platform
- ④ Workshops
- ⑤ Dovecote
- ⑥ Surrounding walls
- ⑦ Restanque



Collectible symbols hidden throughout the site, each corresponding to a specific era.

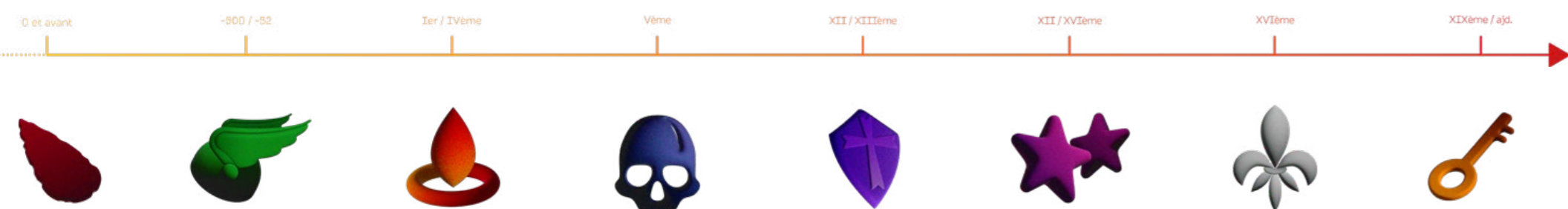

## Renders

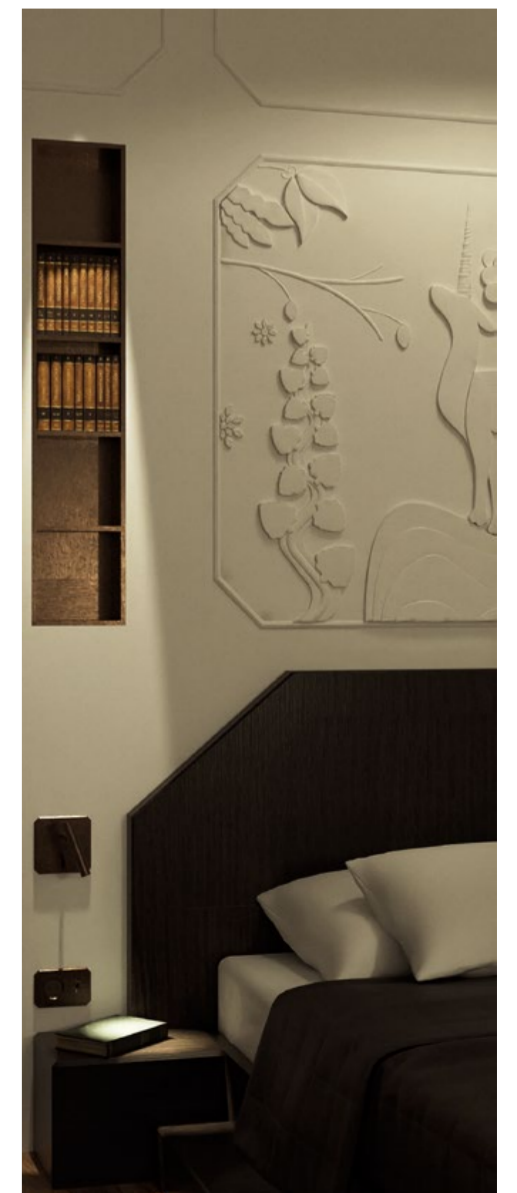

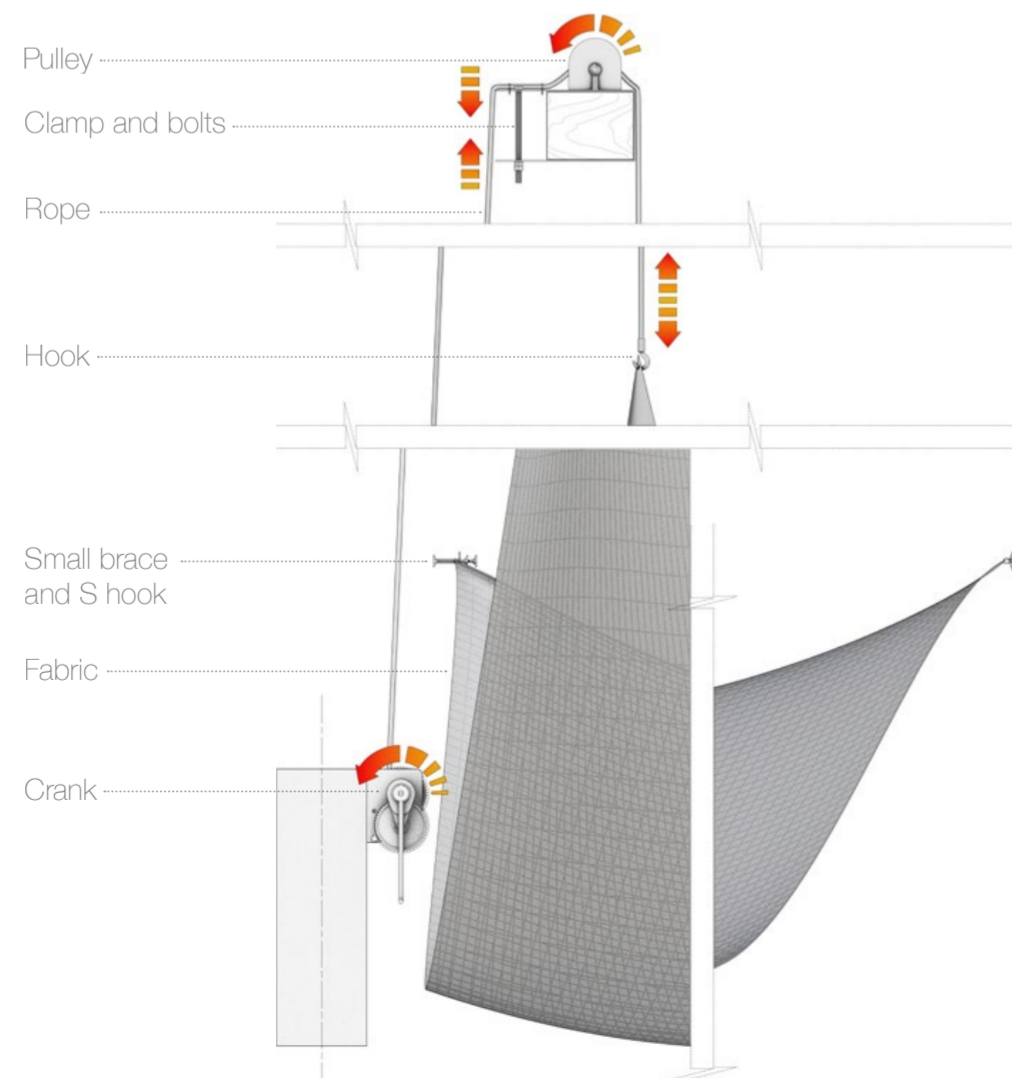
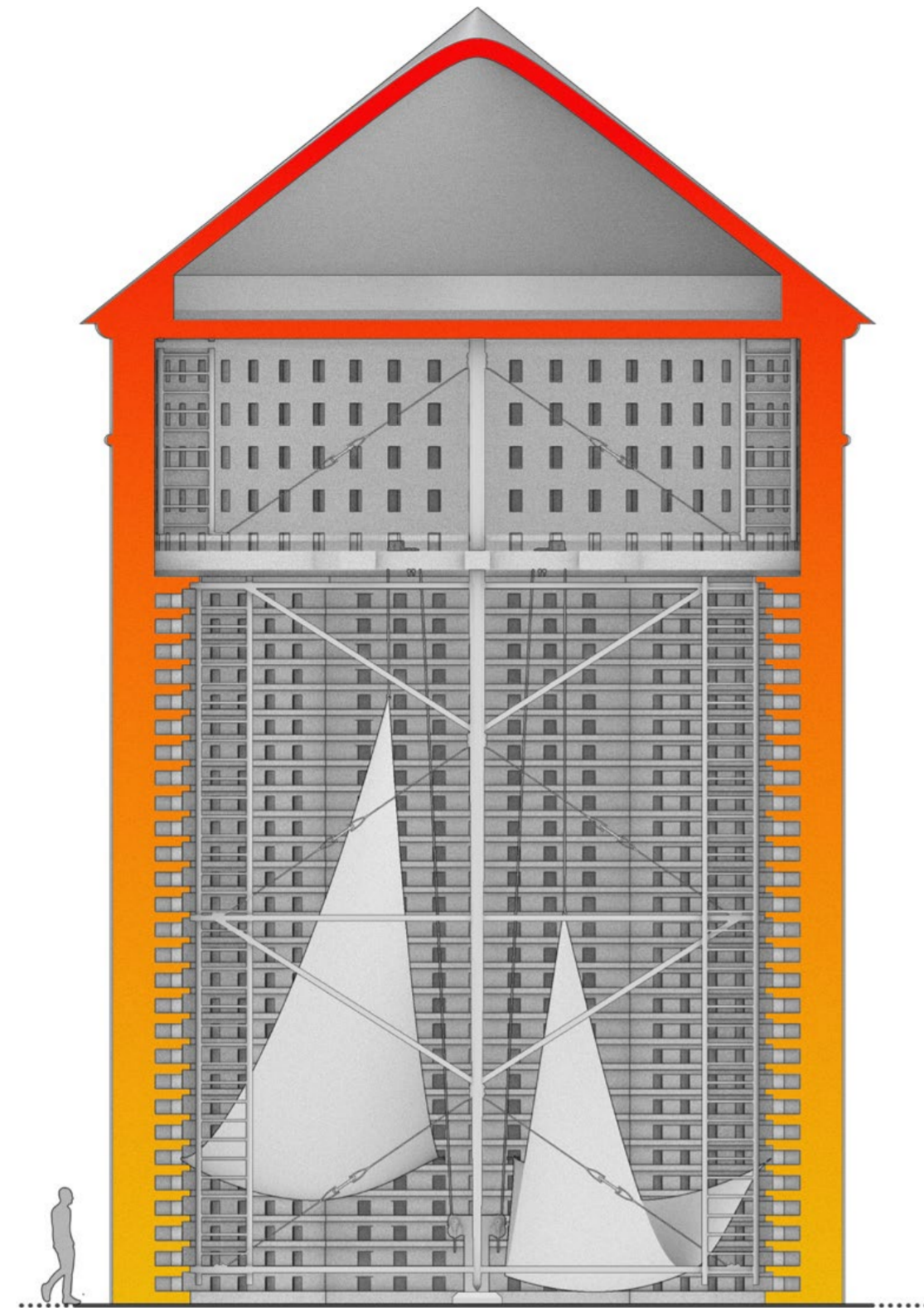

Stables / Workshops

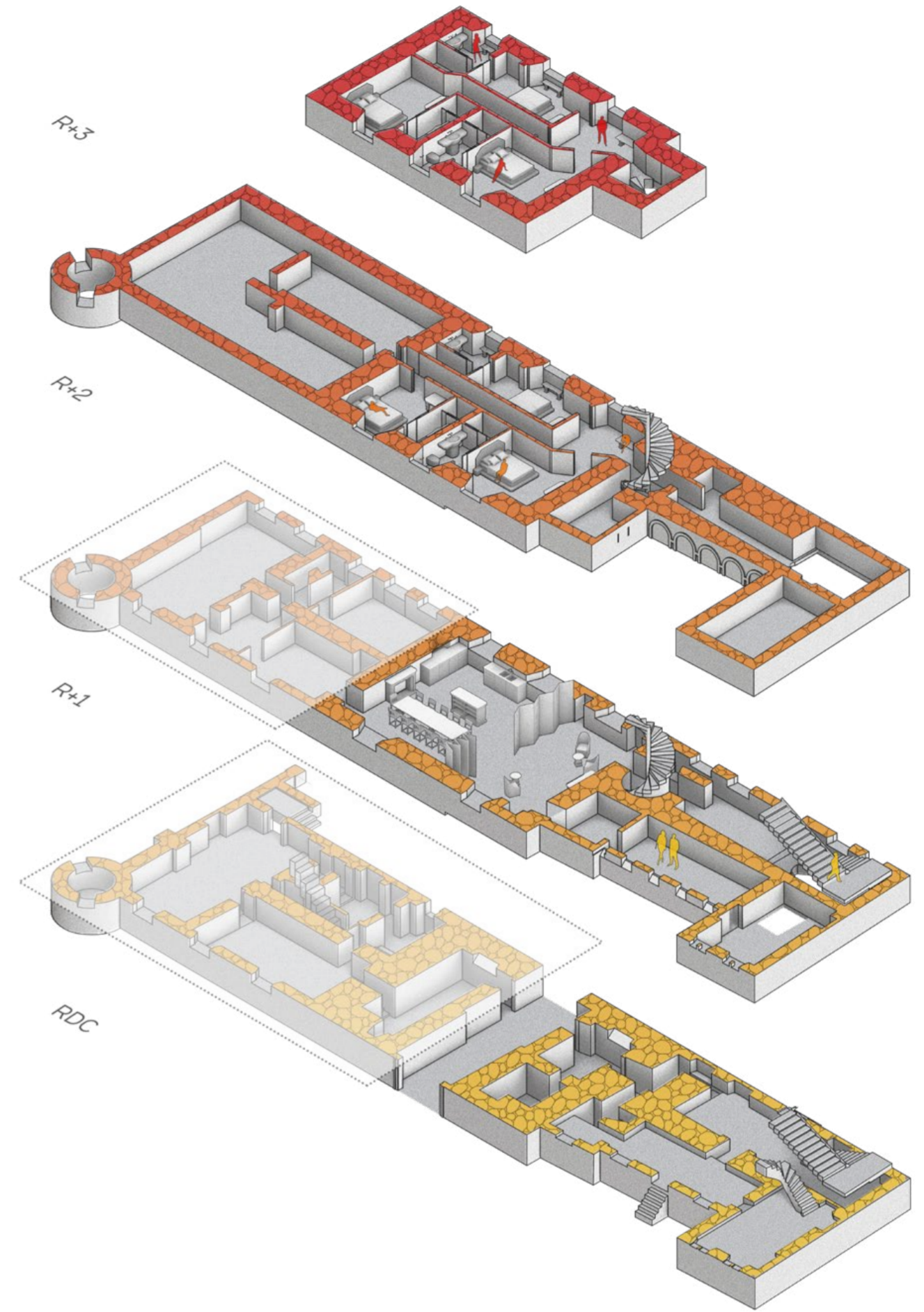

Bedrooms  
- private

Bedrooms and  
exhibition space  
- private / semi-private



Common spaces  
and gite  
- common / private



Common spaces  
and gite  
- common / private

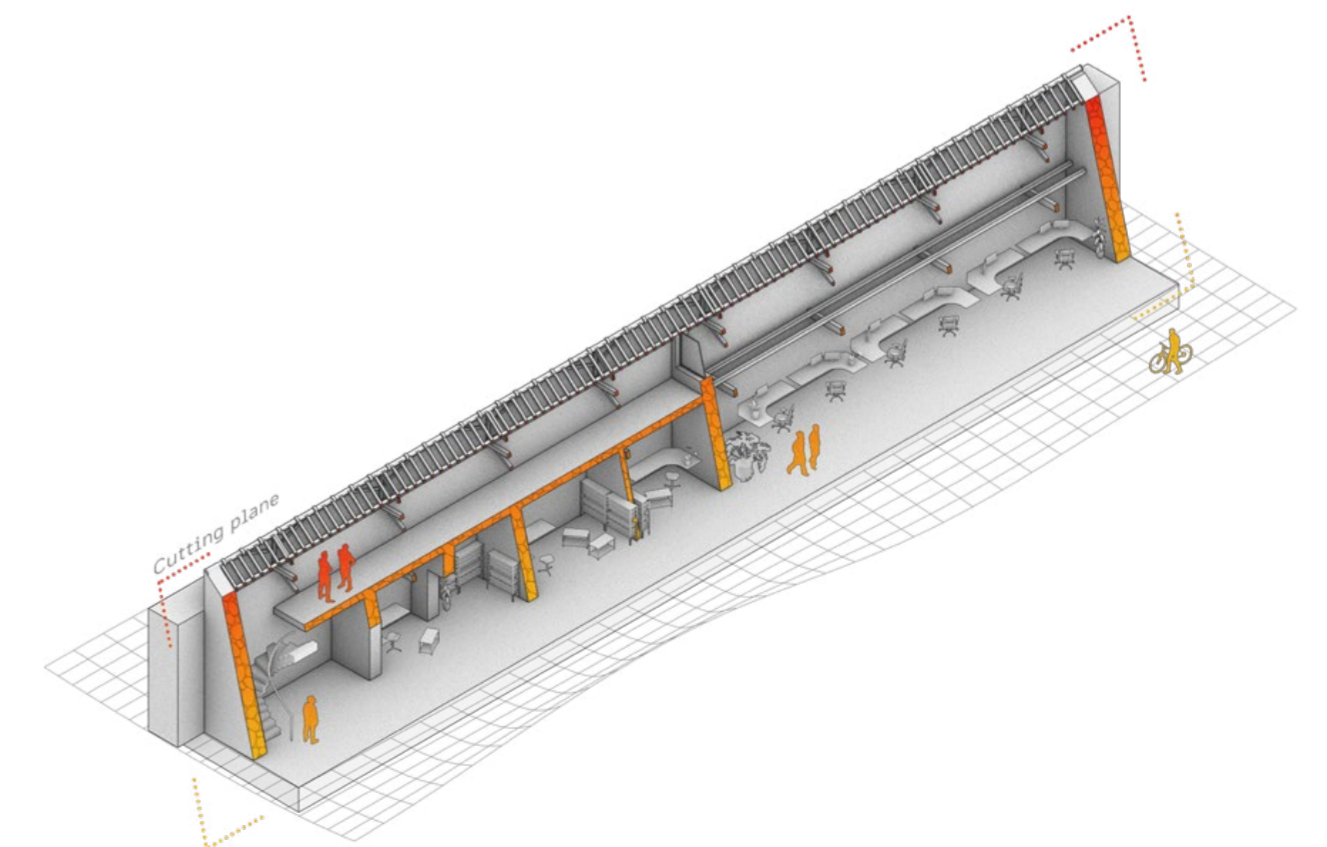

# Le Lab - 2024

## Interior Architecture - Hackerspace

Le Lab is a café / hackerspace located in one of the buildings of the new St Vincent de Paul neighborhood. It's sole objective is to include this new "city in the city" in our contemporary era in which technology is everywhere. Le Lab would be a multifunctional place that aims to connect the people between them and towards the world.

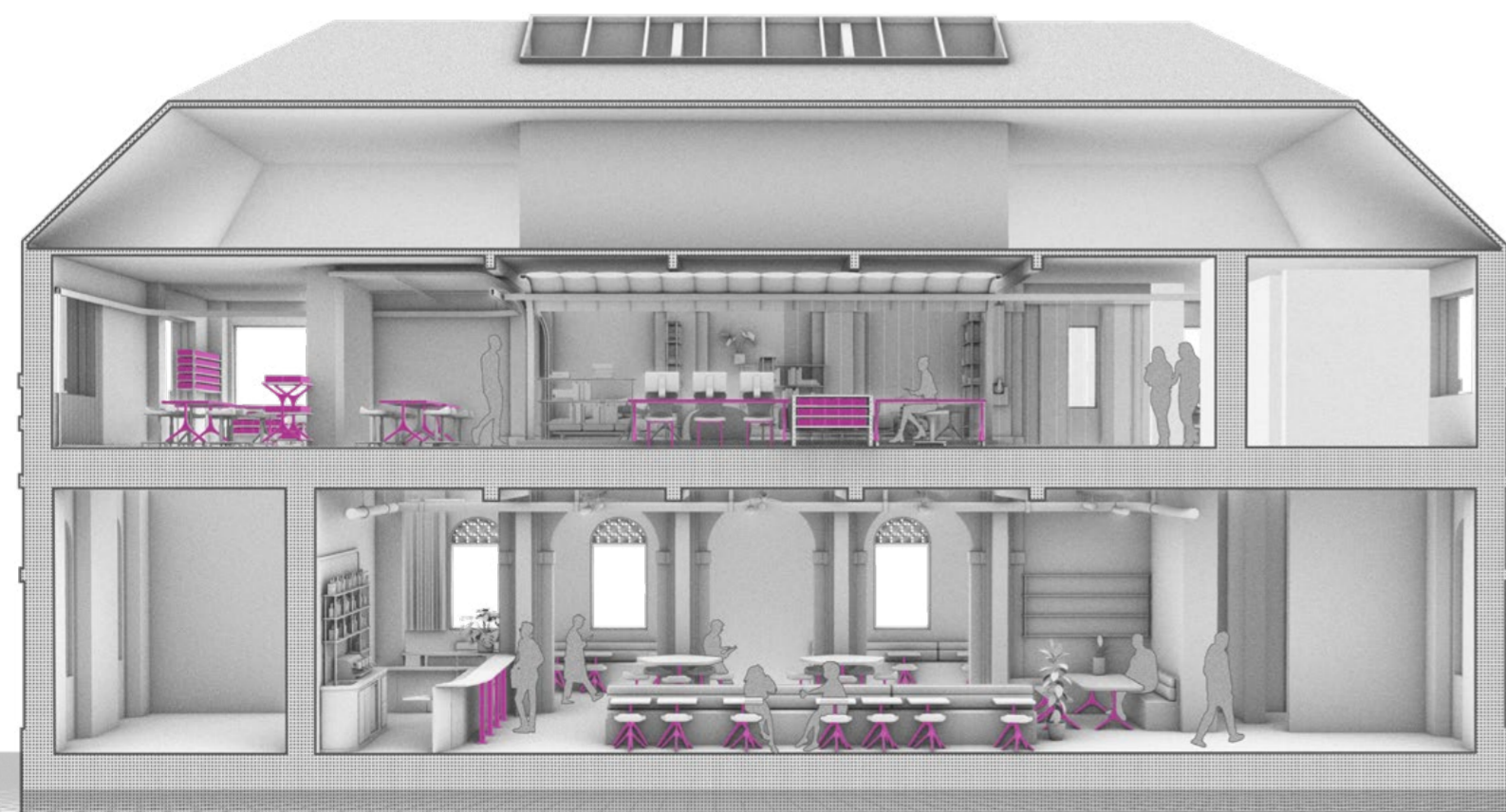
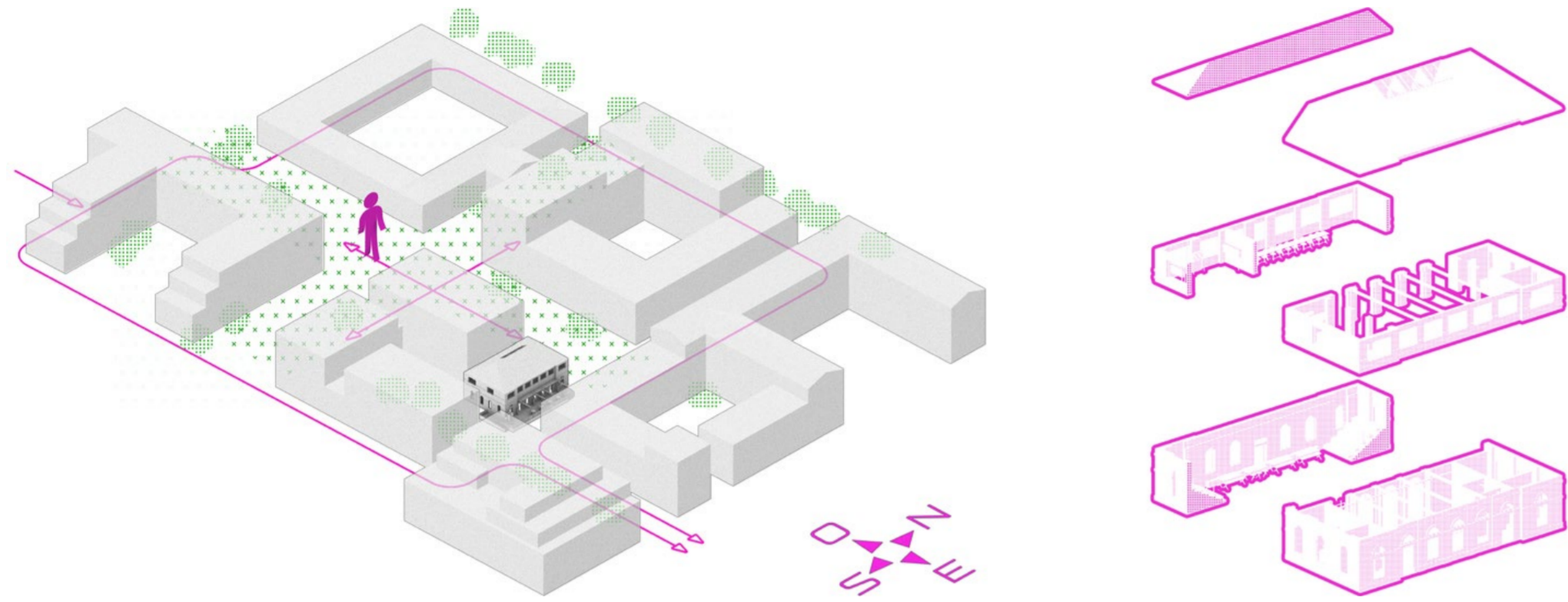

## Project's isometrics

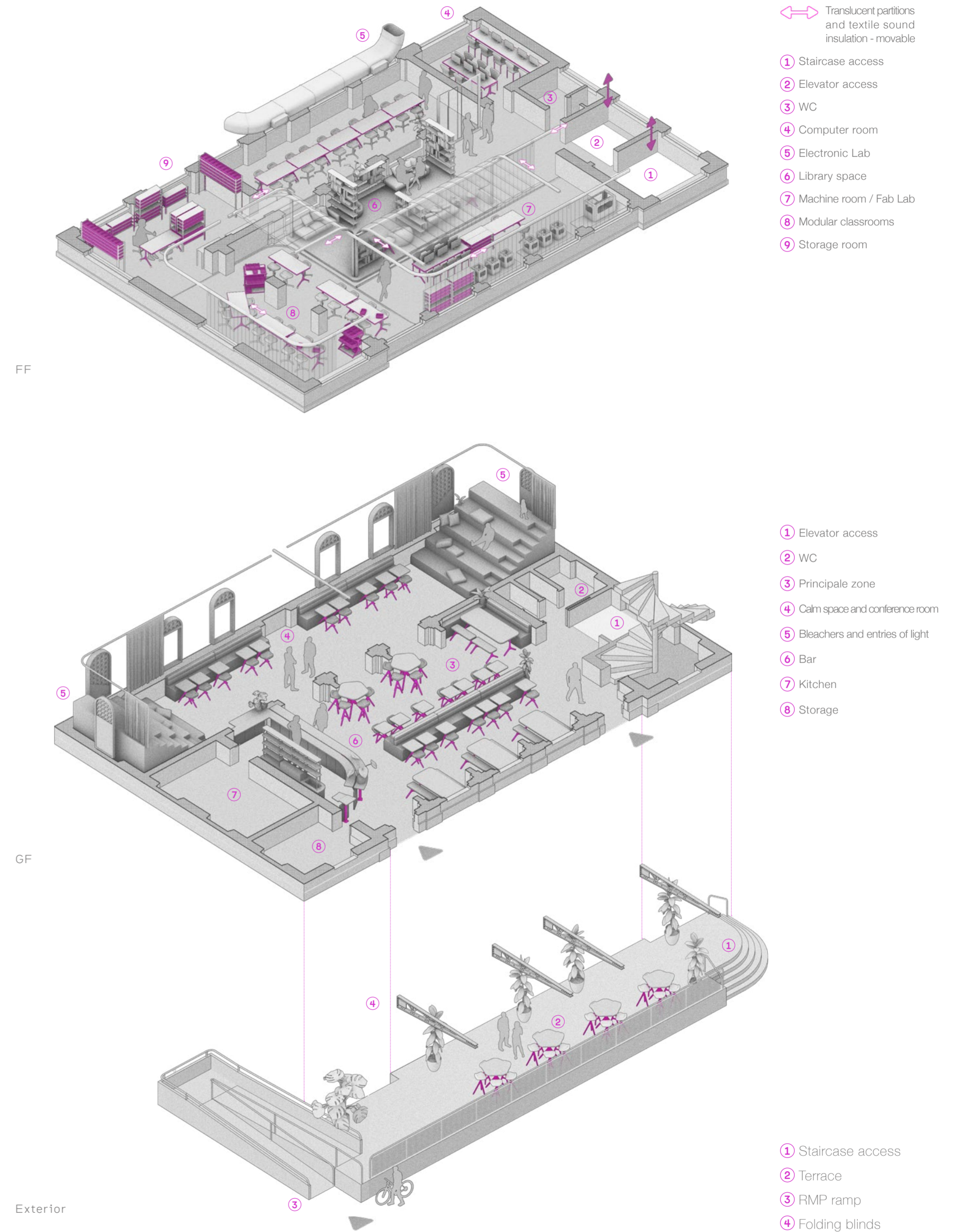

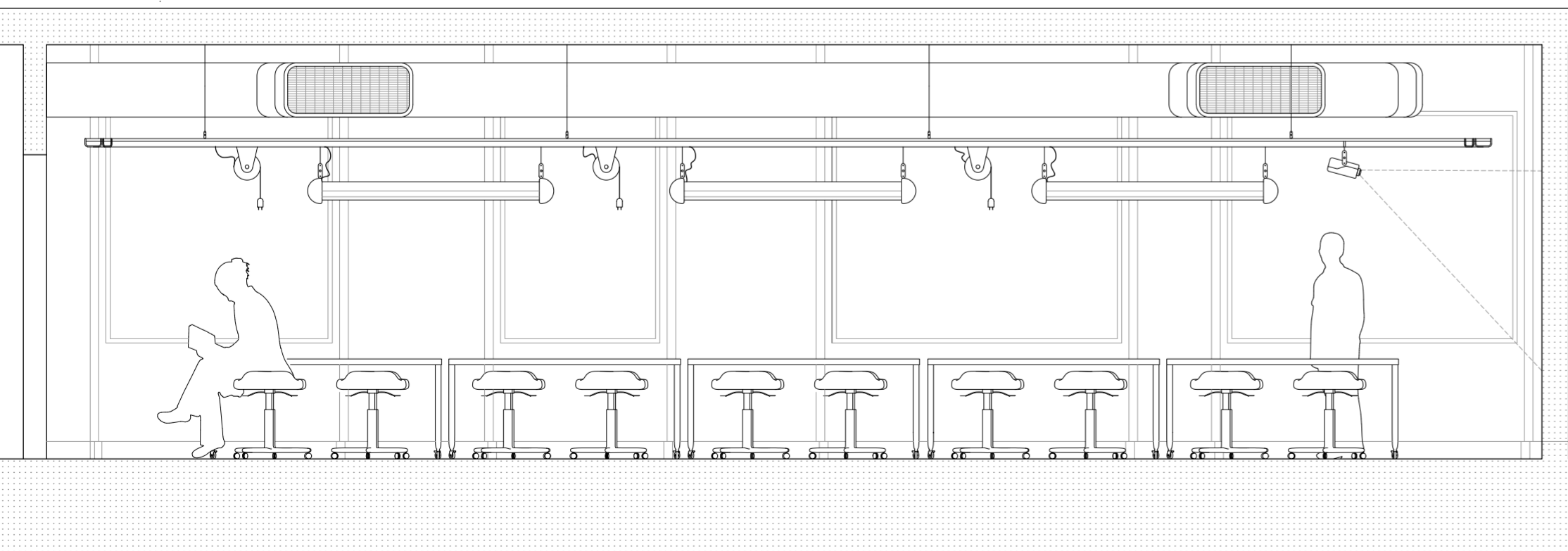
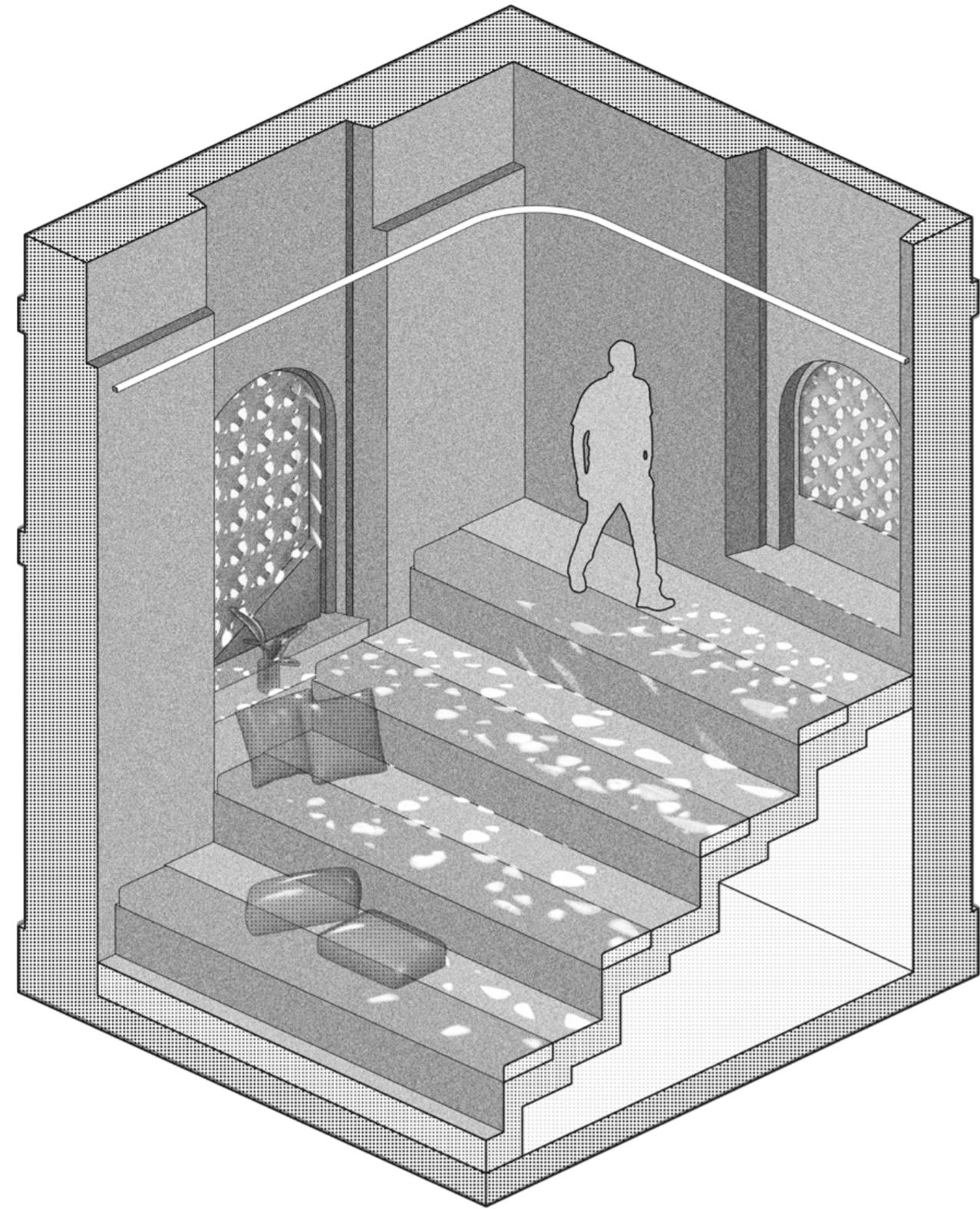



# Calcestruzzo - 2023

## Interior architecture - Villa Medici artist's bedrooms

Calcestruzzo - Italian word for concrete - is a project that aims to explore minimalism and brutalism in the context of an Italian Renaissance Palazzo : the Medici villa. The combination of wood and concrete and the use of terrazzo (a very ancient Italian technique) allow the conjugation of Modern elegance with the strictness of the Cinquecento.

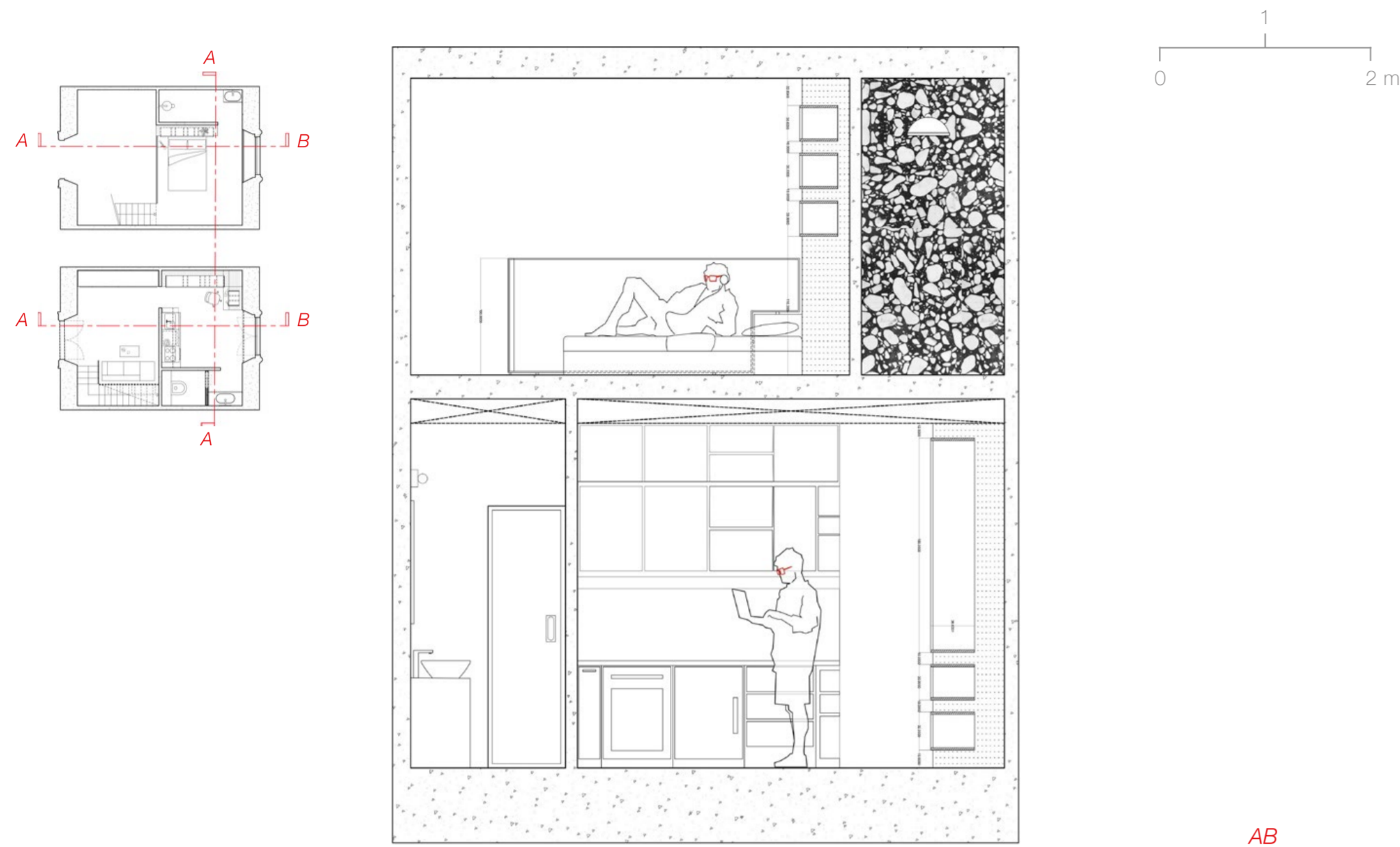

AB

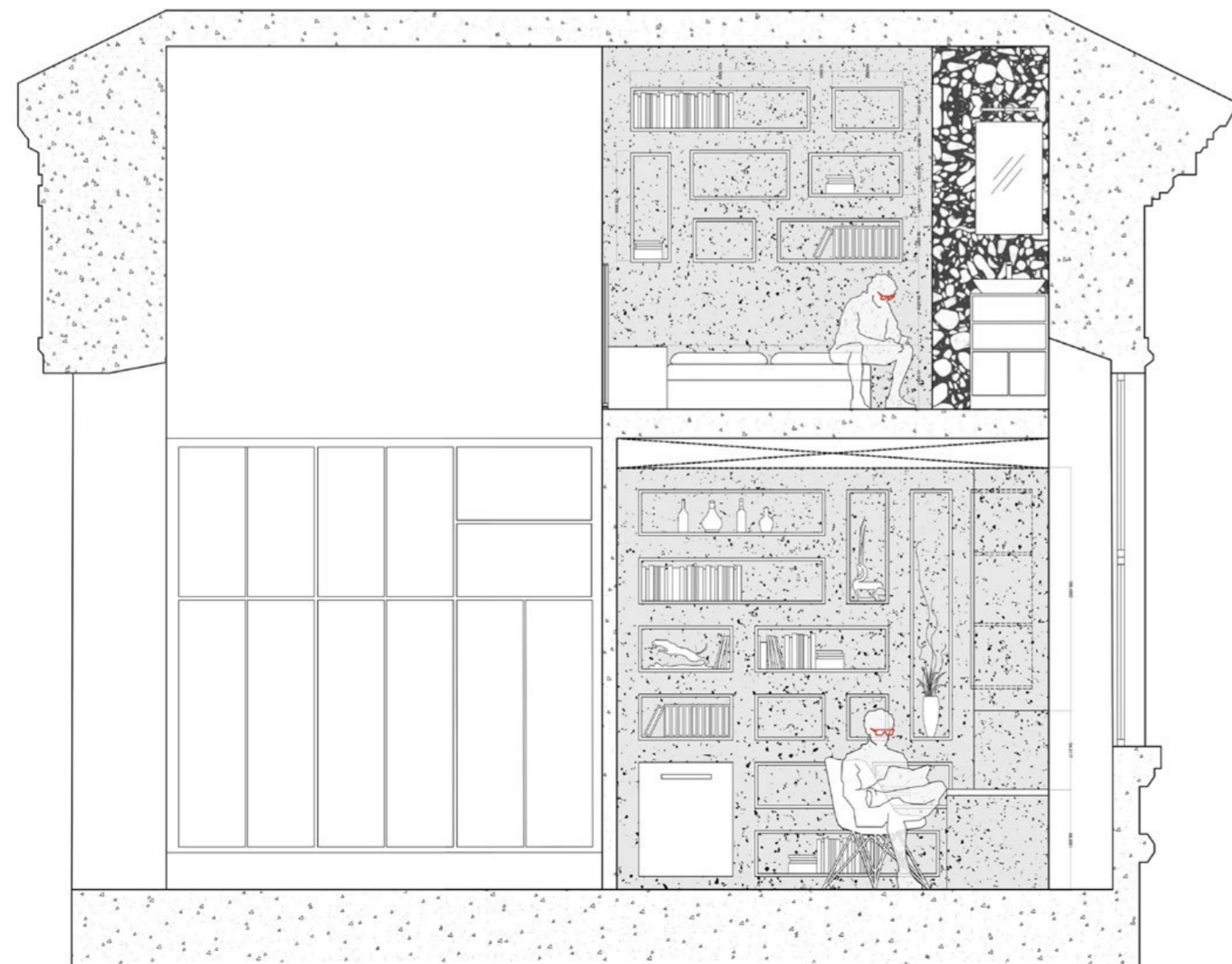

AA

## Renders



# Cinta - 2025

## Microarchitecture - Urban furniture

Cinta is a renovation concept for a square located in the neighborhood of Belgrano, in Buenos Aires, Argentina. The goal was to combine multiple functions in one space and to adapt to the surroundings using parametric tools. The pattern-adorned concrete ribbon all around the square is designed to be a wall, seats, a sound barrier and also to let light in in precise places.

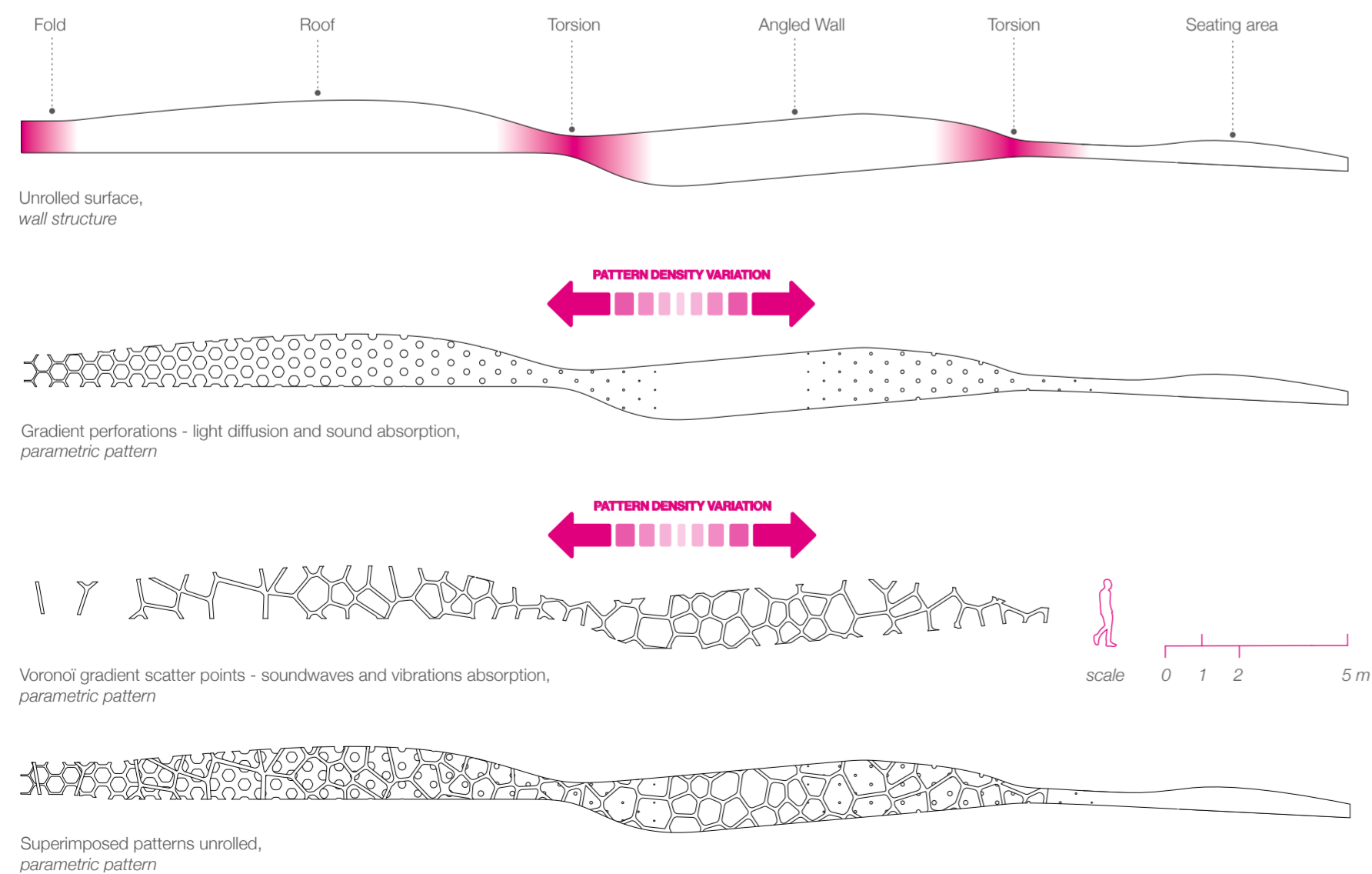
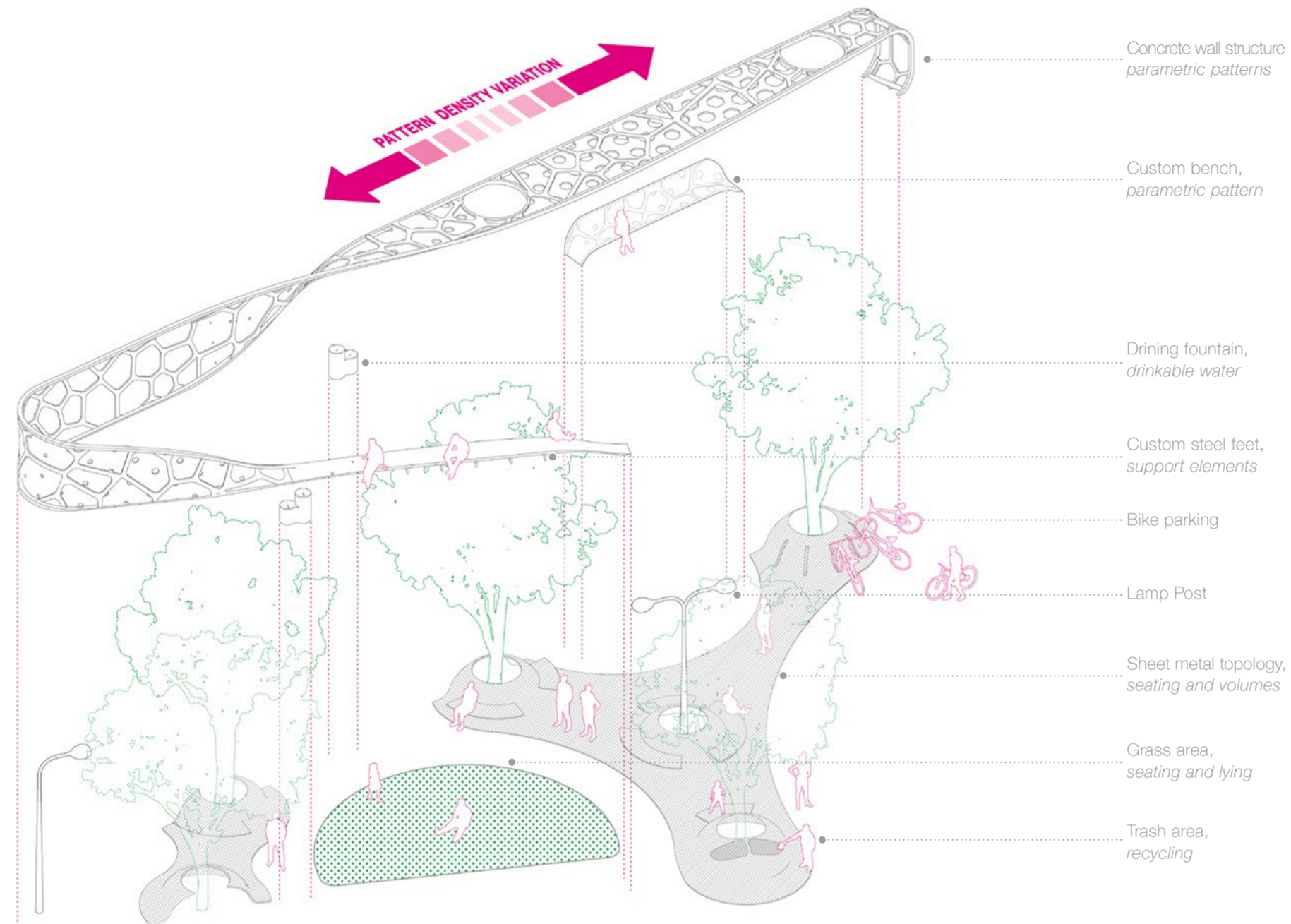

## Renders & research



Parametric research and sketches

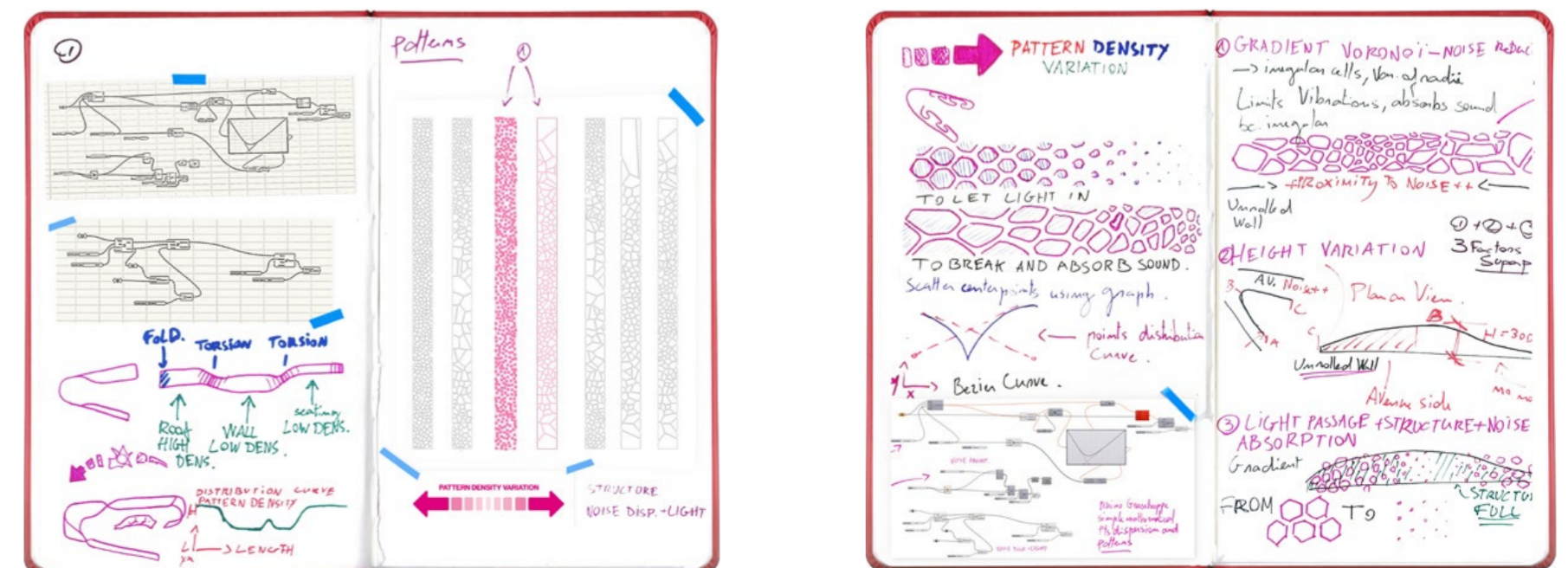

# lonox - 2023

## Microarchitecture - Urban furniture / Modular shelter

lonox is a multifunctional modular shelter. Inspired by the geometry of the pentagon, lonox aims to combine modern aesthetics with Art Nouveau, as it is intended to be installed near Paris metro stations. The shelter's geometry allows for many combinations using 3, 5 or more modules to create a canopy adapted to the site of implantation.



## Renders & visuals

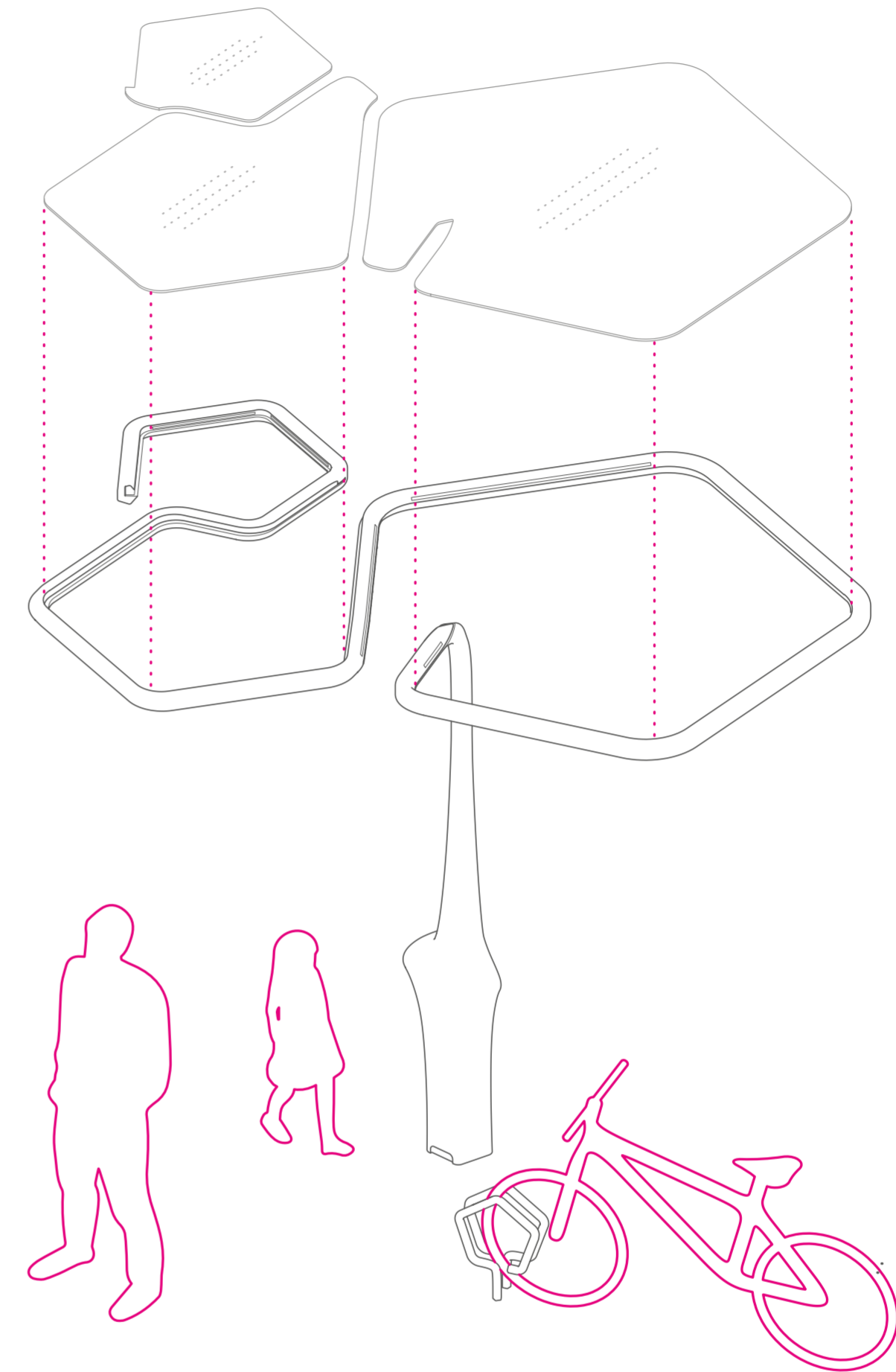

Seating area

Usb ports

Water evacuation

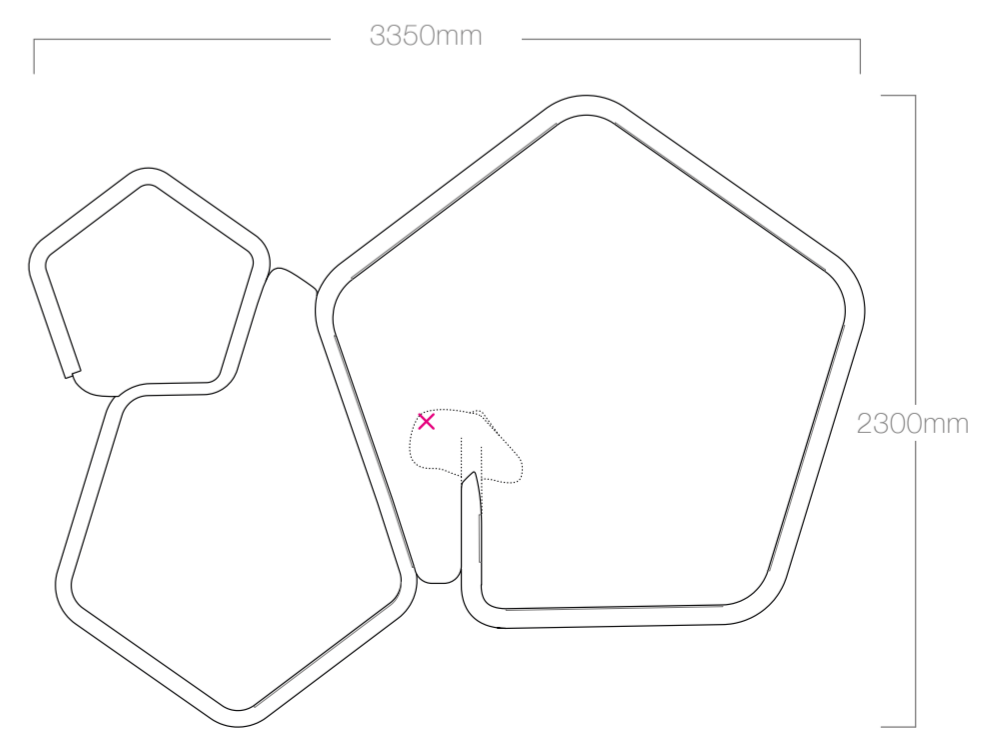

X: Module's centroid

# Split - 2025

## Product design - lamp

Split is a lamp that comes from shape researches and experiments around pipes. It's structure is made out of two precisely bent aluminum tubes that fit together using magnets thus making it possible to "break" or "split" the lamp. The objectives were to obtain a flatpacked, elegant and simple looking object out of very complex processes.



General dimensions 1110 x 630 x 610 mm

## Technicity

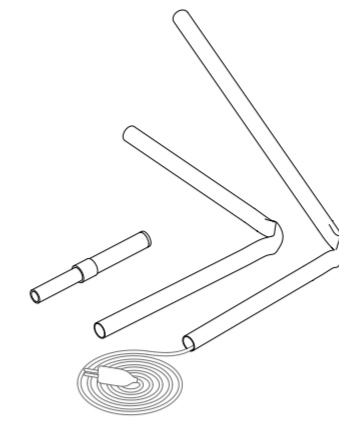

① Open the flatpack

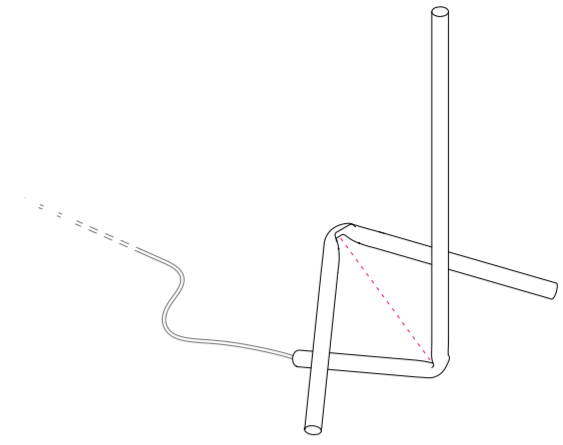

② Assemble the magnetic tubes

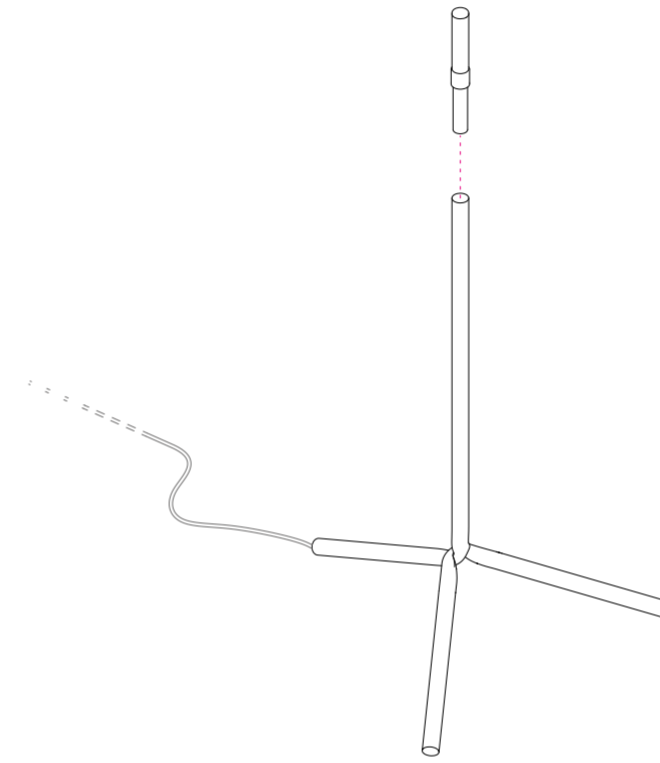

③ Connect the head

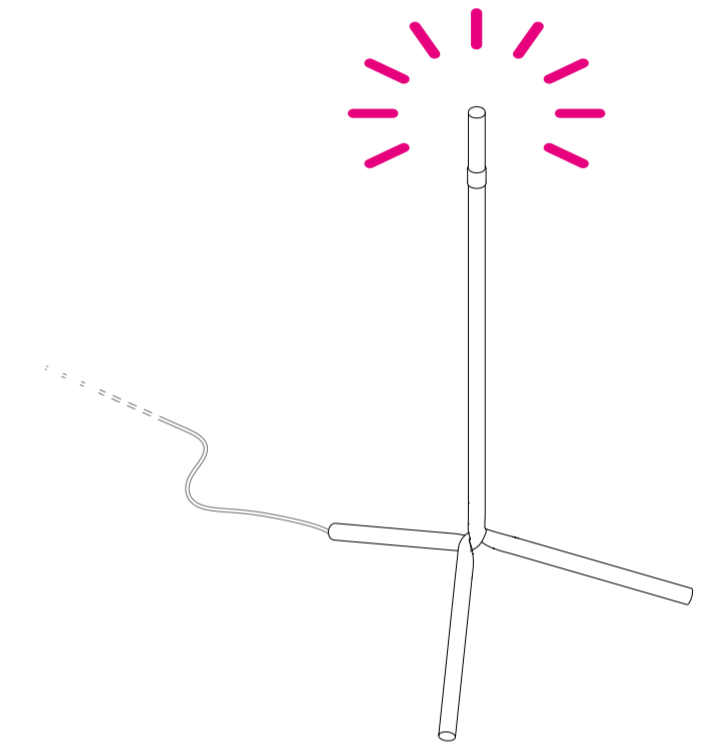

④ Let there be light

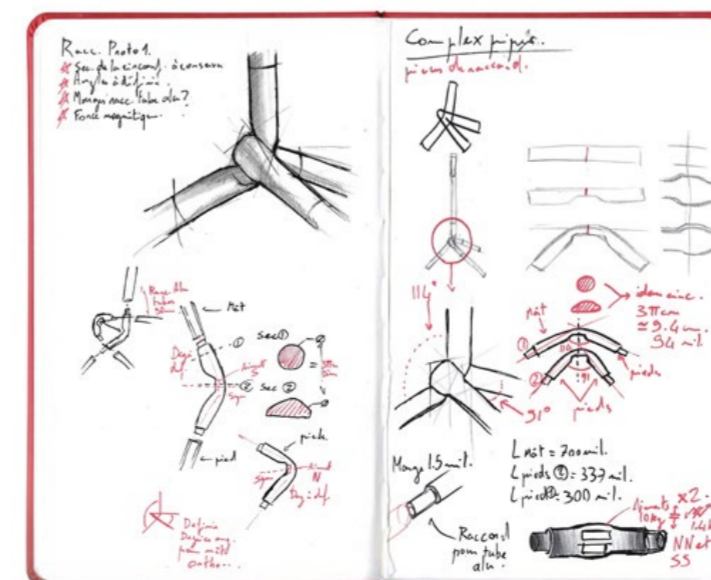
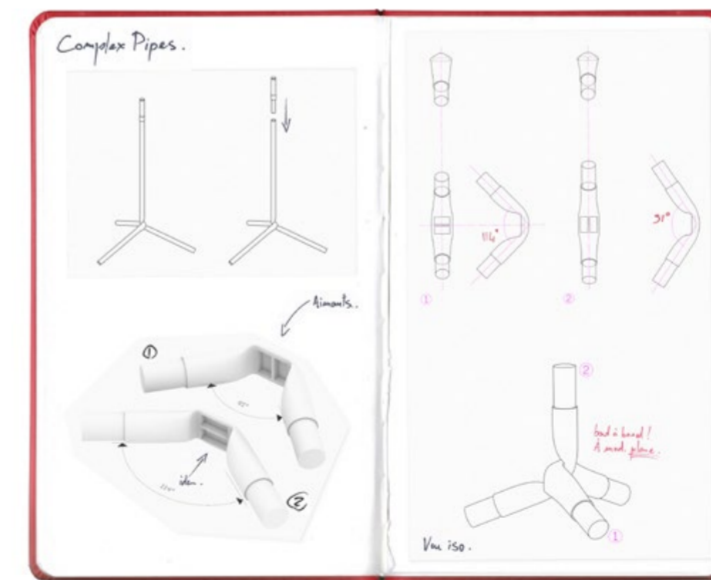

Sketches

Working prototype in the workshop

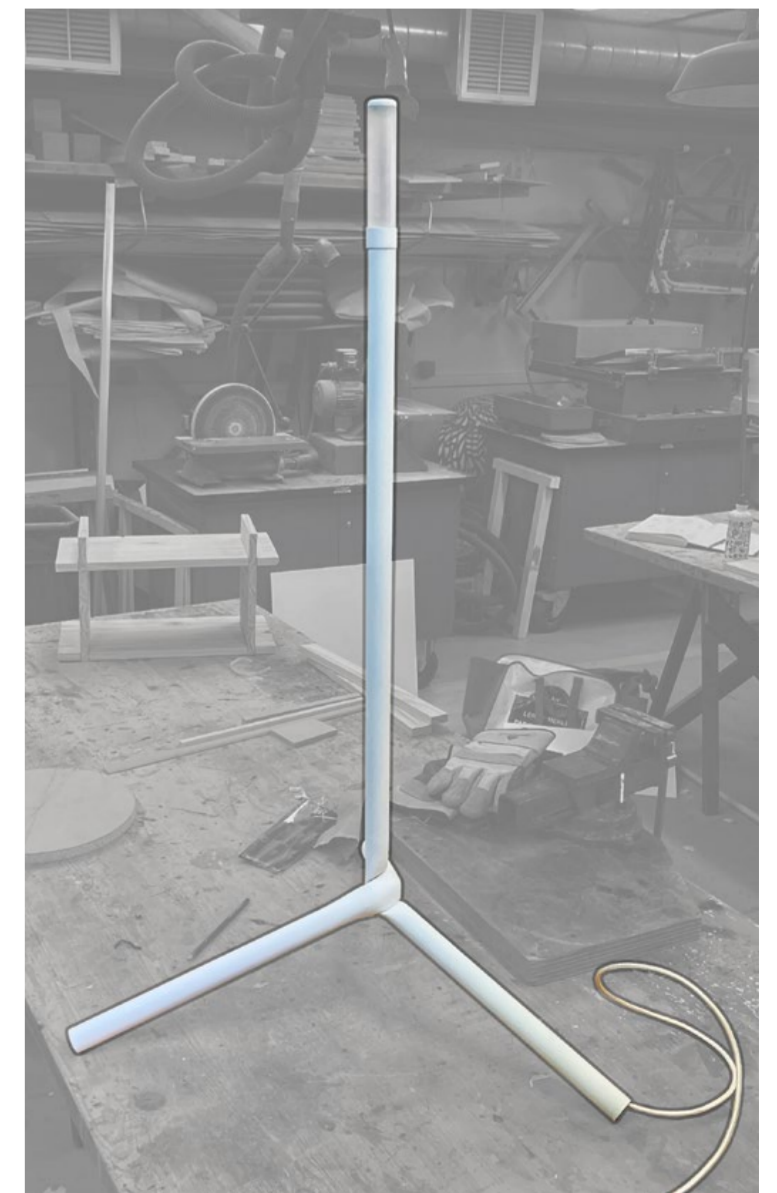

IceBerg - 2022  
Product design - vodka bottle

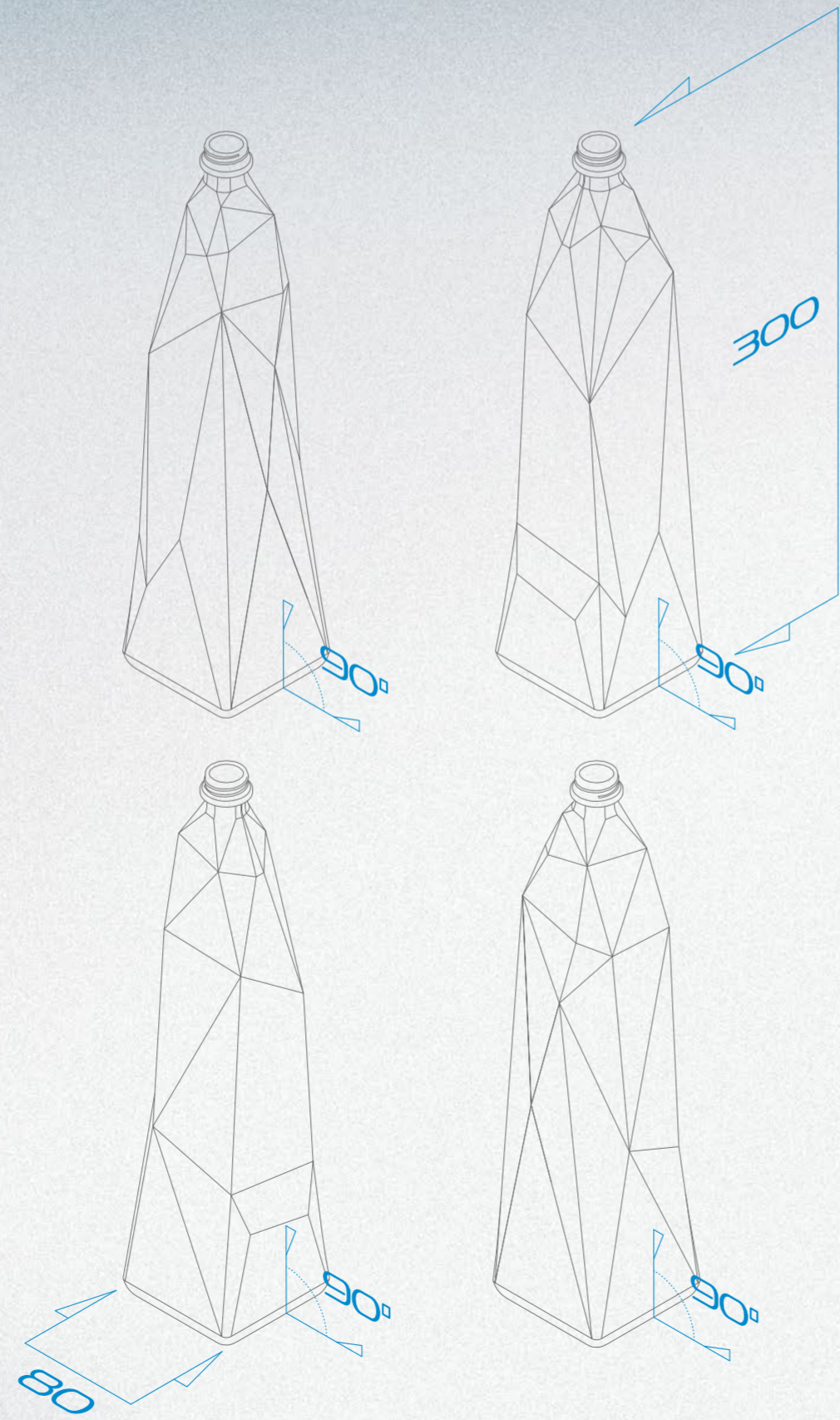
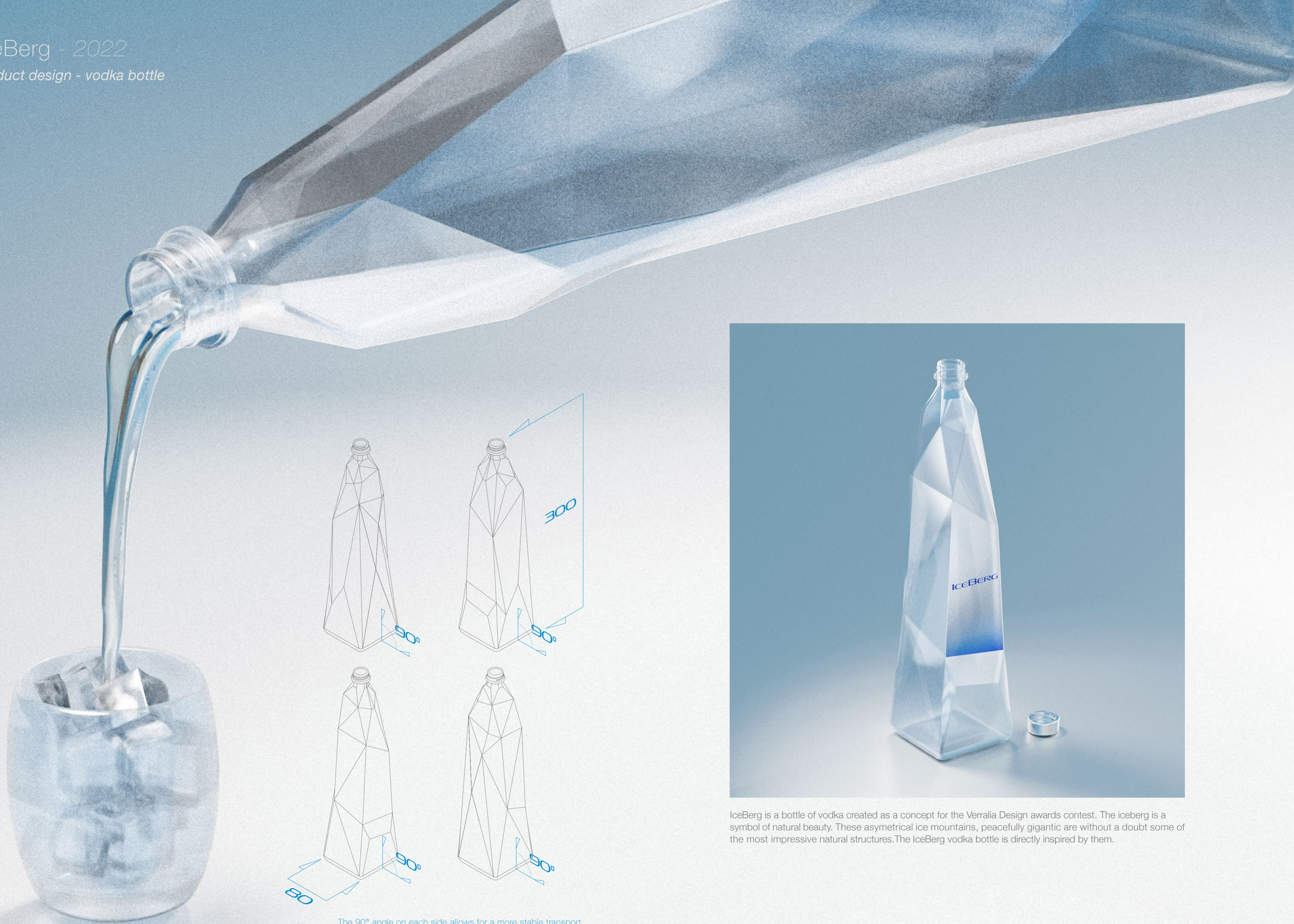

The 90° angle on each side allows for a more stable transport.



IceBerg is a bottle of vodka created as a concept for the Verralia Design awards contest. The iceberg is a symbol of natural beauty. These asymmetrical ice mountains, peacefully gigantic are without a doubt some of the most impressive natural structures. The IceBerg vodka bottle is directly inspired by them.

# Exo - 2024

## Product & service design

EXO is a service thought out to accompany people who smoke and want to follow or diminish their consumption or even stop smoking completely. EXO is a connected object in which one inserts its pack of cigarettes. The app generates statistics and allows the user to set long or short term goals.



### Sketches and visual research

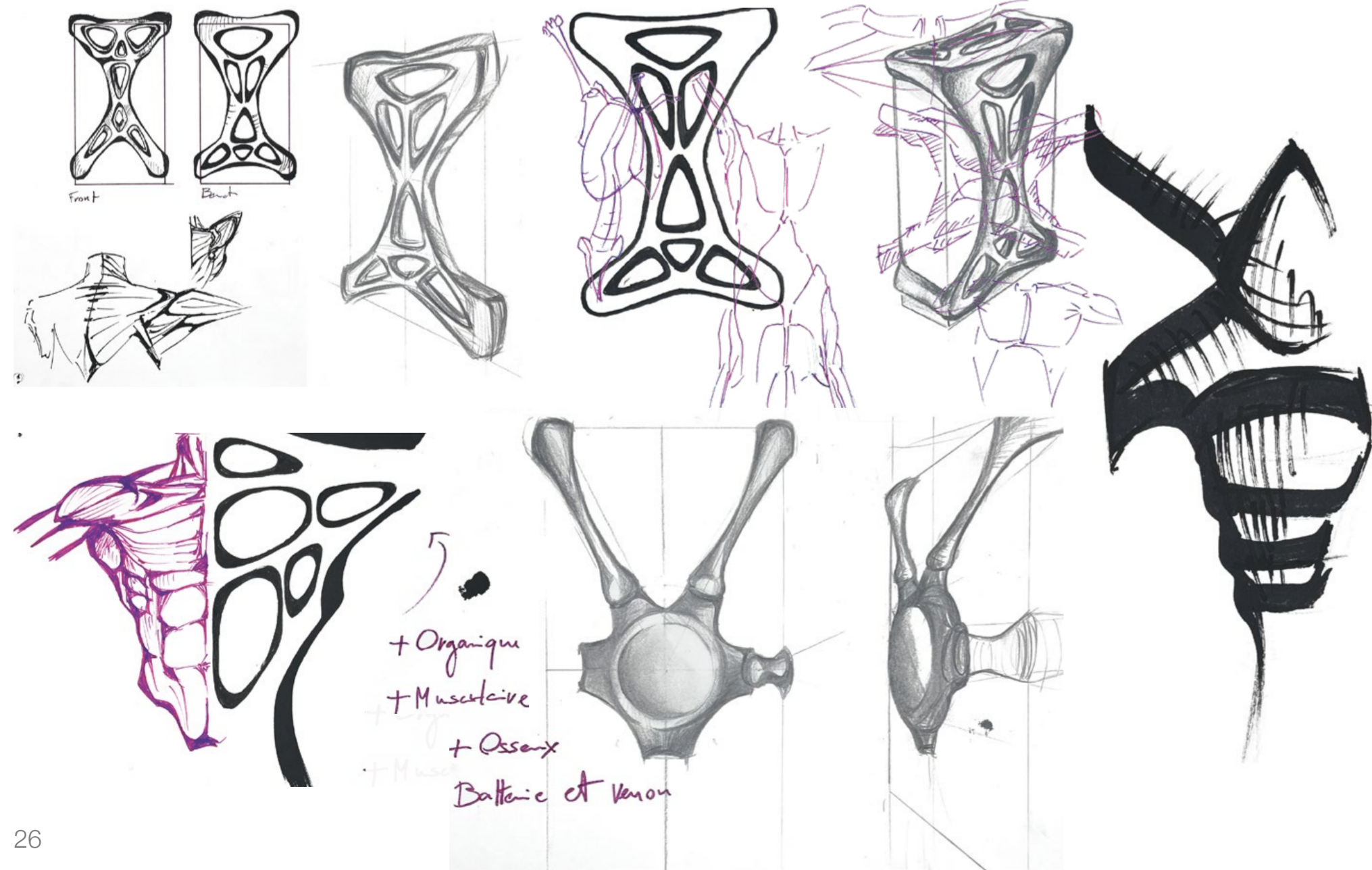

## Technicity



1. Install app, create a user profile and order Exo.



2. After delivery, open Exo.

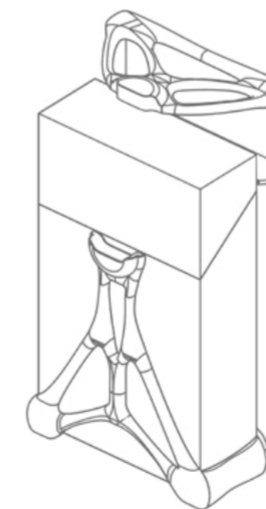

3. Insert cigarette pack.

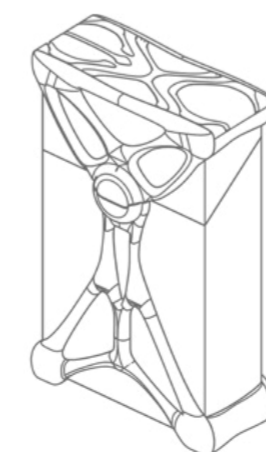

4. Depending on your set objectives, the follow-up begins and statistics are created.

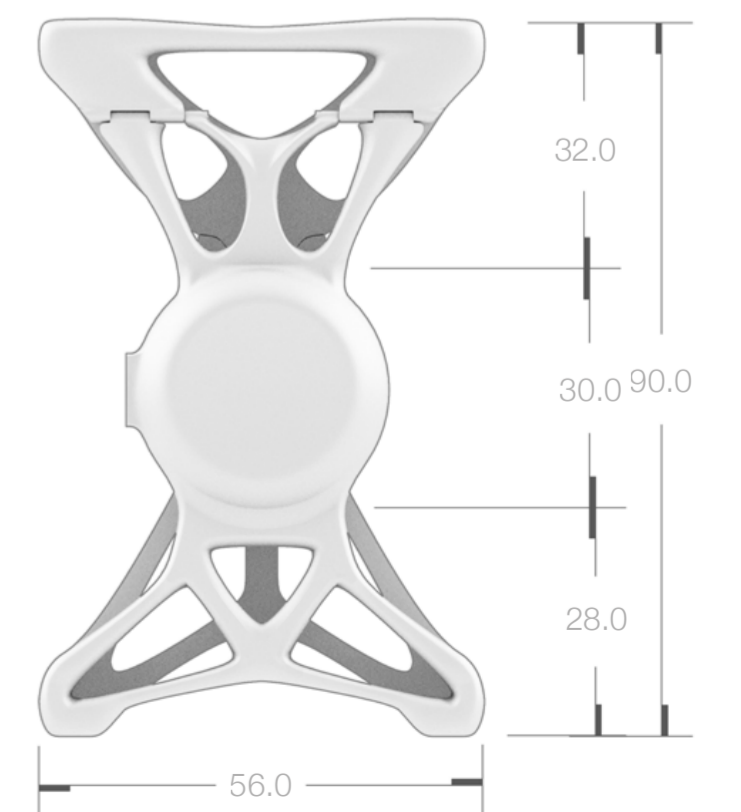
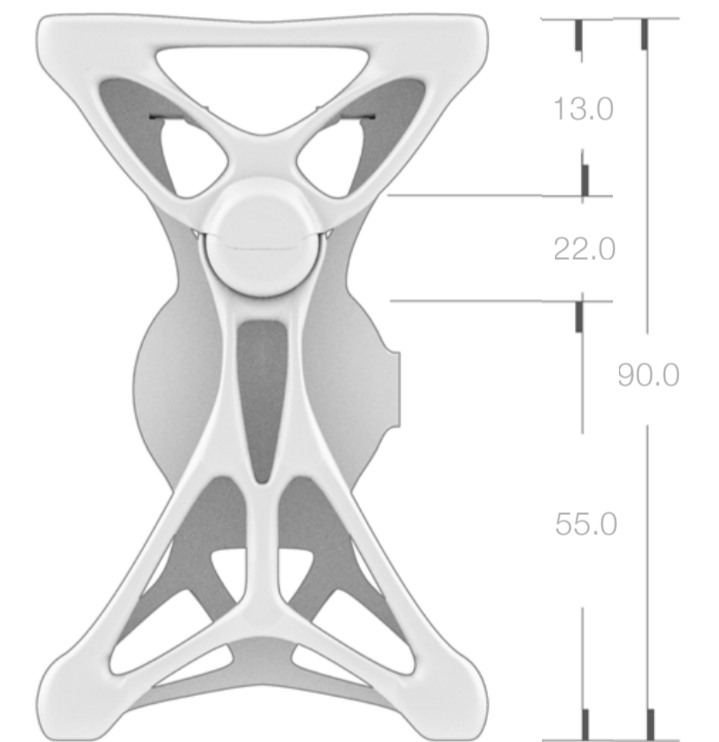

# Elastic - 2025

## Product design - sunglasses

These sunglasses are multipurposed technical gear / sport sunglasses conceived to be worn for skiing, kite-surfing, running or else. The double bungee cord and adjustable elastic band combo make them hard to lose and wearable around your neck while adaptable to any head shape .



## Renders



Parametric texture

Adjustable buckle



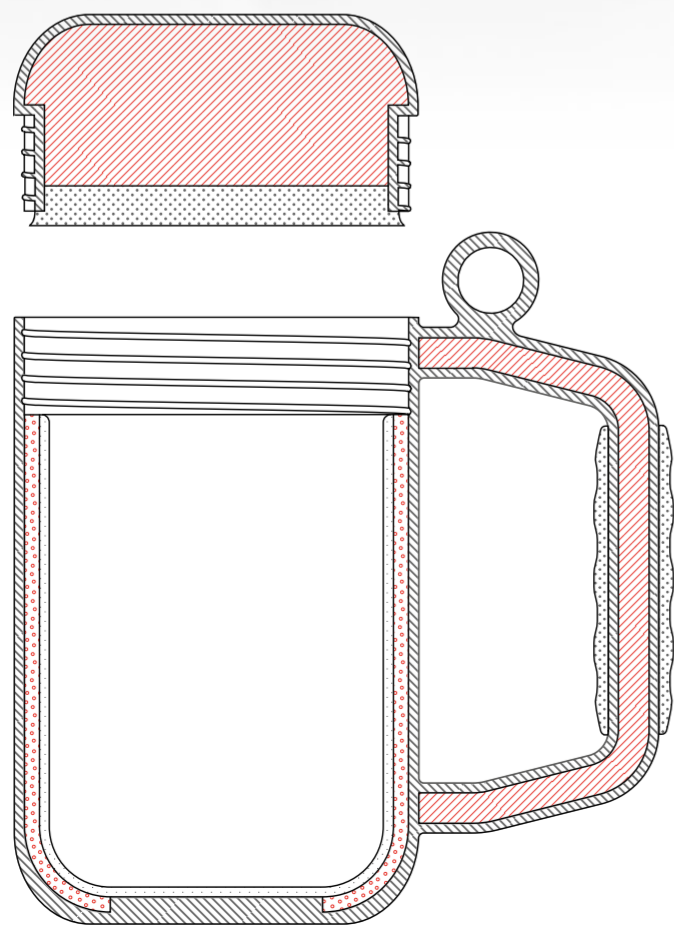

# ThermoMug - 2023

## Product design - isothermal mug

ThermoMug is a high-end isotherm mug designed to adapt to all lifestyles through its technical features and ergonomic design. Both a personal item and a functional accessory, it combines durable materials with elegant aesthetics, ensuring long-lasting performance over time.



Maximum volume capacity :  
33 cL/11.2 oz

-  : Internal empty space
-  : Steel
-  : Rubber
-  : Vacuum
-  : Reflective surface

Central cross section

## Visuals and technicity

